

 **Pelsan**

40 **Aydınlık**
Yıl

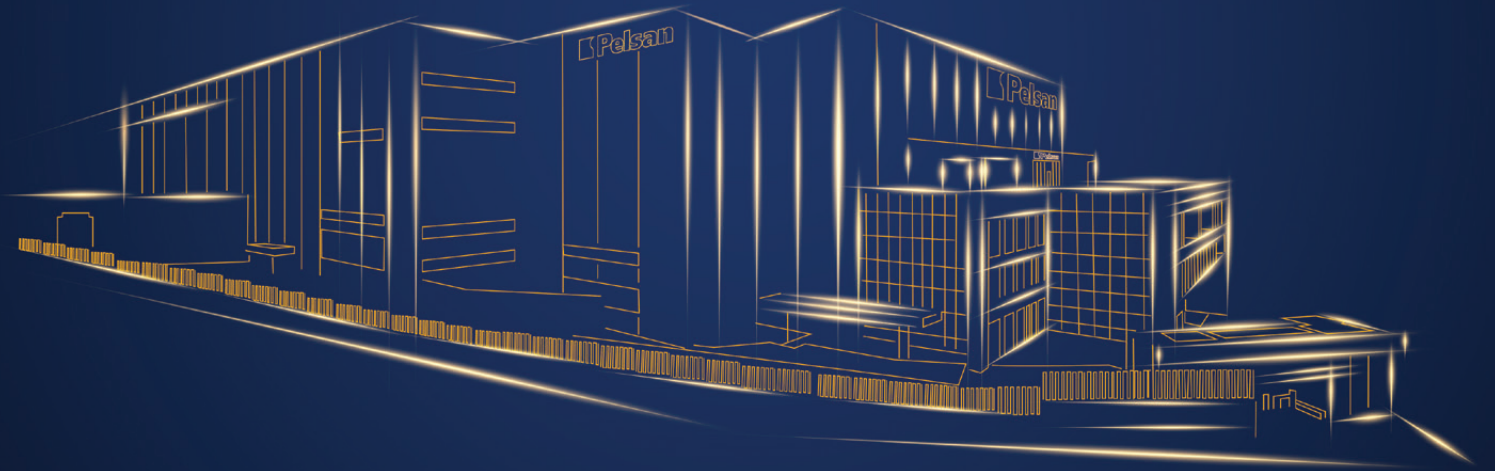

AĞUSTOS 2022
FİYAT LİSTESİ

Sirma

Slim Backlight Downlight



Birebir Değişim Garantisi



Dahili Sürücü



Slim Tasarım



Backlight Işık Konforu



Acil Kit Uygulaması



3000K / 4000K / 6500K

6W-9W

12W-15W

18W

Diğer Downlight Armatürler



Tira Ip54
Sıva Altı



Tira
Sıva Altı



Rina
Sıva Üstü



Dore
Sıva Altı

Yüksek Tavan Armatürü

Pelsan

Cronto IP66

5
YIL
GARANTİ

400W



En zor
koşullarda
7/24 çalışır!

150-400W 

100.000h Driver Ömrü 

10kV Dahili Parafudr 

IK10, Kırılmaz Gövde 

IP66, Toz ve Su Almaz! 

Gerilim Dalgalanmalarından
Etkilenmez 100-305VAC @48h 



Lens Opsiyonları

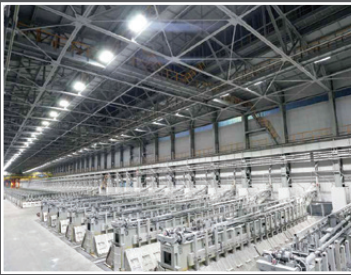

Diğer Yüksek Tavan Armatürleri



Castor G2

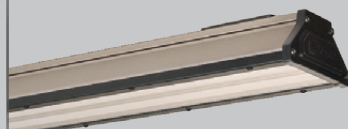





Etna G2



Neta



Sia

08 Backlight Ofis Armatürleri	
09 Sıva Üstü Backlight Ofis Armatürleri	
12 Sıva Altı ve Sıva Üstü Backlight Ofis Armatürleri	
13 Steril Ortam ve Hastane Armatürleri	
14 UGR Ofis / Lineer Armatürleri	
15 Lineer Armatürler	
18 Mimari Armatürler	
22 Dekoratif Sarkıt Armatürler	
23 Duvar Aplikler	
24 Downlight Armatürler	
28 LED Spotlar	
31 Tavan / Duvar Armatürleri	
32 Sensörlü Armatürler	

<p>33 Dış Mekan Tavan/ Duvar Armatürleri</p>	
<p>35 Sensörler</p>	
<p>36 Acil Aydınlatma Armatürleri</p>	
<p>38 Acil Aydınlatma ve Yönlendirme Armatürleri</p>	
<p>41 Süpermarket Armatürleri</p>	
<p>42 Bant Armatürleri</p>	
<p>43 Etanj Armatürleri</p>	
<p>44 Özel Etanj Armatürler</p>	
<p>45 Alüminyum Etanj Armatürler</p>	
<p>46 PC Etanj Armatürler</p>	
<p>47 LED Tube Etanj</p>	
<p>48 Benzinlik Armatürler</p>	
<p>49 Sabit Gerilim 24V Armatürler</p>	

50 Yüksek Tavan Armatürler	
56 Ex-Proof Armatürler	
58 Wallwasher	
59 Yüksek Güçlü Projektörler	
60 Profesyonel Projektörler	
62 LED Projektörler	
66 IP66 LED Yol Aydınlatma Armatürleri	
68 LEDli Yol Aydınlatma Armatürleri	
70 Sokak Armatürleri	
71 LEDli Park Bahçe Aydınlatma Armatürleri	
78 Park Bahçe Aydınlatma Armatürleri	
79 Direkler	
80 Bolardlar	

<p>83 Çimen Armatürleri/ Gömme Armatürler</p>	
<p>84 Dış Mekan Aplikler</p>	
<p>85 Park Bahçe Aplikler</p>	
<p>86 Set Üstü Armatürler</p>	
<p>87 Şerit Neonlar</p>	
<p>88 LED Lambalar</p>	
<p>90 LED Tube</p>	
<p>91 Balastlar & Kitler</p>	
<p>93 Grup Prizler</p>	
<p>95 Grup Prizler & Aksesuarlar</p>	
<p>96 Anahtar ve Prizler</p>	
<p>97 Sertifikalar</p>	

Pelsan Backlight Ofis Armatürleri

Kurum Şartnamelerine Uygun

5
YIL
GARANTİ



Isoled
Sıva Altı Ofis Armatürü



Dekoled
Sıva Üstü Ofis Armatürü



TSE Belgeli



ENEC Belgeli Sürücü



50.000 Saatlik Ömür



Lensli Modül



PF > 0,95

Isoled 60x60
Sıva Altı



IP 40 ● 3000K ● 4000K ● 6500K

Kod No	Özellikler	Koli Adedi	Fiyat
111474	36W 60X60 S.A. 4000K	6	36,40 \$
111475	36W 60X60 S.A. 6500K	6	36,40 \$

Isoled 30x30
Sıva Altı

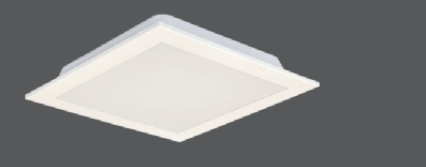

IP 40 ● 3000K ● 4000K ● 6500K

Kod No	Özellikler	Koli Adedi	Fiyat
113676	12W 30X30 S.A. 4000K	5	21,95 \$
113677	12W 30X30 S.A. 6500K	5	21,95 \$

Isoled 30x60
Sıva Altı

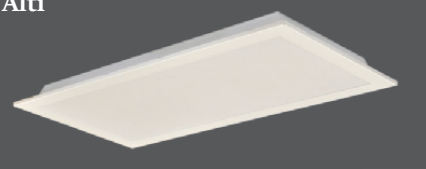

IP 40 ● 3000K ● 4000K ● 6500K

Kod No	Özellikler	Koli Adedi	Fiyat
111821	17W 30x60 S.A. 4000K	5	31,00 \$
111822	17W 30x60 S.A. 6500K	5	31,00 \$

Isoled 30x120
Sıva Altı



IP 40 ● 3000K ● 4000K ● 6500K

Kod No	Özellikler	Koli Adedi	Fiyat
113008	36W 30x120 S.A. 4000K	4	49,60 \$
113009	36W 30x120 S.A. 6500K	4	49,60 \$

Isoled 60x120
Sıva Altı



IP 40 ● 4000K ● 6500K

Kod No	Özellikler	Koli Adedi	Fiyat
113246	72W 60x120 4000K	20	92,30 \$
113247	72W 60x120 6500K	20	92,30 \$

Isoled UGR
Sıva Altı



IP 40 ● 3000K ● 4000K ● 6500K

Kod No	Özellikler	Koli Adedi	Fiyat
109519	36W 60X60 S.A. 4000K	5	42,70 \$
109511	36W 60X60 S.A. 6500K	5	42,70 \$

Opsiyonlar

Kod No	Özellikler	Koli Adedi	Fiyat
313118	Isoled & Dekoled Acil Aydınlatma Kiti (1 saat)	1	26,00 \$
316611	Isoled & Dekoled Acil Aydınlatma Kiti (3 saat)	1	30,30 \$
323795	Isoled Alçıpan Yayısı (4 adet) (60x60 için)	1	3,51 \$
325628	Isoled Alçıpan Yayısı (2 adet) (30x30 için)	1	3,51 \$

Özellikler	Koli Adedi	Fiyat Farkı
Triac Dim	1	28,50 \$
1-10V Dim	1	31,25 \$
DALI Dim	1	31,25 \$
PMMA Difüzör	1	5,50 \$

Sıva Üstü Backlight Ofis Armatürleri

Dekoled 60x60
Sıva Üstü



IP 40  ● 3000K ● 4000K ● 6500K

55mm

Lensli Modül

Kod No	Özellikler	Koli Adedi	Fiyat
111499	36W 60x60 S.Ü. 4000K	6	43,00 \$
111500	36W 60x60 S.Ü. 6500K	6	43,00 \$

60x60 Radar Sensörlü
Sıva Üstü



IP 40  ● 3000K ● 4000K ● 6500K

55mm

Lensli Modül

Acil

Kod No	Özellikler	Koli Adedi	Fiyat
108786	36W 60x60 S.Ü. 6500K	5	65,40 \$
108785	36W 60x60 S.Ü. 6500K Radar Sens. + Acil Ayd. Kit	5	91,40 \$

Dekoled 30x30
Sıva Üstü



IP 40  ● 3000K ● 4000K ● 6500K

55mm

Tarak PCB

Kod No	Özellikler	Koli Adedi	Fiyat
111588	12W 30x30 S.Ü. 4000K	5	26,20 \$
111589	12W 30x30 S.Ü. 6500K	5	26,20 \$

30x30 Radar Sensörlü
Sıva Üstü



IP 40  ● 3000K ● 4000K ● 6500K

55mm

Tarak PCB

Acil

Kod No	Özellikler	Koli Adedi	Fiyat
108780	12W 30x30 S.Ü. 6500K	5	43,10 \$
109086	12W 30x30 S.Ü. 6500K Radar Sens. + Acil Ayd. Kit	5	70,70 \$

Dekoled 30x120
Sıva Üstü

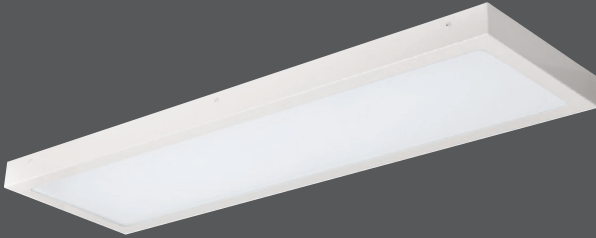

IP 40  ● 3000K ● 4000K ● 6500K

55mm

Lensli Modül

Tarak PCB

Kod No	Özellikler	Koli Adedi	Fiyat
113041	36W 30x120 S.Ü. 4000K	4	58,40 \$
113042	36W 30x120 S.Ü. 6500K	4	58,40 \$

Dekoled 30x60
Sıva Üstü



IP 40  ● 3000K ● 4000K ● 6500K

55mm

Lensli Modül

Kod No	Özellikler	Koli Adedi	Fiyat
111839	17W 30x60 S.Ü. 4000K	5	36,60 \$
111840	17W 30x60 S.Ü. 6500K	5	36,60 \$

Dekoled 60x120
Sıva Üstü



IP 40  ● 3000K ● 4000K ● 6500K

55mm

Lensli Modül

Kod No	Özellikler	Koli Adedi	Fiyat
113353	72W 60x120 S.Ü. 4000K	2	127,10 \$
113354	72W 60x120 S.Ü. 6500K	2	127,10 \$

Sooled1 60x60
Sıva Üstü



IP 40  ● 3000K ● 4000K ● 6500K

69mm

Kod No	Özellikler	Koli Adedi	Fiyat
109516	36W 60x60 S.Ü. 6500K	4	74,60 \$

Pelsan Backlight Ofis Armatürleri

Kurum Şartnamelerine Uygun

5 YIL GARANTİ



Isoled
Sıva Altı Ofis Armatürü



Dekoled
Sıva Üstü Ofis Armatürü



TSE Belgeli



Avrupa Menşei ENEC Sürücü



+118 lm/W



50.000 Saatlik Ömür



Tarak PCB



PF > 0,95



PMMA Difüzör



55mm Kasa Kalınlığı

Isoled 60x60
Sıva Altı



IP 40 ● 3000K ● 4000K ● 6500K

Kod No	Özellikler	Koli Adedi	Fiyat
111411	36W 60X60 S.A. 4000K	6	45,20 \$
111412	36W 60X60 S.A. 6500K	6	45,20 \$

Isoled 30x30
Sıva Altı



IP 40 ● 3000K ● 4000K ● 6500K

Kod No	Özellikler	Koli Adedi	Fiyat
111342	12W 30X30 S.A. 4000K	5	23,30 \$
111343	12W 30X30 S.A. 6500K	5	23,30 \$

Isoled 30x60
Sıva Altı



IP 40 ● 3000K ● 4000K ● 6500K

Kod No	Özellikler	Koli Adedi	Fiyat
111461	17W 30x60 S.A. 4000K	5	38,80 \$
111462	17W 30x60 S.A. 6500K	5	38,80 \$

Isoled 30x120
Sıva Altı



IP 40 ● 3000K ● 4000K ● 6500K

Kod No	Özellikler	Koli Adedi	Fiyat
111464	36W 30x120 S.A. 4000K	4	60,50 \$
111465	36W 30x120 S.A. 6500K	4	60,50 \$

Isoled 60x120 Yeni Ürün



IP 40 ● 4000K ● 6500K

Kod No	Özellikler	Koli Adedi	Fiyat
113369	72W 60x120 S.A. 4000K	20	113,10 \$
113370	72W 60x120 S.A. 6500K	20	113,10 \$

Divaled Endirekt
Sıva Altı / Sıva Üstü



IP 20 ● 3000K ● 4000K ● 6500K

Kod No	Özellikler	Koli Adedi	Fiyat
108125	42W 60x60 S.A. 4000K	4	67,40 \$
110601	42W 60x60 S.Ü. 4000K	4	67,40 \$

Opsiyonlar

Kod No	Özellikler	Koli Adedi	Fiyat
313118	Isoled & Dekoled Acil Aydınlatma Kiti (1 saat)	1	26,00 \$
316611	Isoled & Dekoled Acil Aydınlatma Kiti (3 saat)	1	30,30 \$
323795	Isoled Alçıpan Yayı (4 adet) (60x60 için)	1	3,51 \$
325628	Isoled Alçıpan Yayı (2 adet) (30x30 için)	1	3,51 \$

Özellikler	Koli Adedi	Fiyat Farkı
Triac Dim	1	28,50 \$
1-10V Dim	1	31,25 \$
DALI Dim	1	31,25 \$
PMMA Dif Farkı	1	5,50 \$

Sıva Üstü Backlight Ofis Armatürleri

Dekoled 60x60
Sıva Üstü





IP 40  ● 3000K ● 4000K ● 6500K

Tarak PCB

Kod No	Özellikler	Koli Adedi	Fiyat
111439	36W 60x60 S.Ü. 4000K	6	51,40 \$
111440	36W 60x60 S.Ü. 6500K	6	51,40 \$

60x60 Radar Sensörlü
Sıva Üstü



IP 40  ● 3000K ● 4000K ● 6500K

Tarak PCB

Acil

Kod No	Özellikler	Koli Adedi	Fiyat
108786	33W 60x60 S.Ü. 6500K	5	65,40 \$
108785	33W 60x60 S.Ü. 6500K Radar Sens. + Acil Ayd. Kit	5	91,40 \$

Dekoled 30x30
Sıva Üstü





IP 40  ● 3000K ● 4000K ● 6500K

Tarak PCB

Kod No	Özellikler	Koli Adedi	Fiyat
111357	12W 30x30 S.Ü. 4000K	5	26,50 \$
111358	12W 30x30 S.Ü. 6500K	5	26,50 \$

30x30 Radar Sensörlü
Sıva Üstü





IP 40  ● 3000K ● 4000K ● 6500K

Acil

Kod No	Özellikler	Koli Adedi	Fiyat
108780	12W 30x30 S.Ü. 6500K	5	40,50 \$
109086	12W 30x30 S.Ü. 6500K Radar Sens. + Acil Ayd. Kit	5	66,50 \$

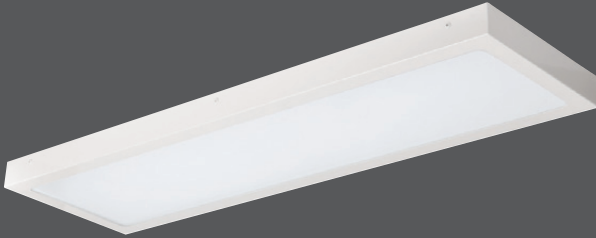
Dekoled 30x120
Sıva Üstü



IP 40  ● 3000K ● 4000K ● 6500K

Tarak PCB

Kod No	Özellikler	Koli Adedi	Fiyat
111458	36W 30x120 S.Ü. 4000K	4	71,30 \$
111459	36W 30x120 S.Ü. 6500K	4	71,30 \$

Dekoled 30x60
Sıva Üstü





IP 40  ● 3000K ● 4000K ● 6500K

Tarak PCB

Kod No	Özellikler	Koli Adedi	Fiyat
111455	17W 30x60 S.Ü. 4000K	5	44,10 \$
111456	17W 30x60 S.Ü. 6500K	5	44,10 \$

Dekoled 60x120
Sıva Üstü





IP 40  ● 3000K ● 4000K ● 6500K

Tarak PCB

Kod No	Özellikler	Koli Adedi	Fiyat
113392	72W 60x120 S.Ü. 4000K	2	127,70 \$
113393	72W 60x120 S.Ü. 6500K	2	127,70 \$

Seoled1 60x60
Sıva Üstü





IP 40  ● 3000K ● 4000K ● 6500K

Kod No	Özellikler	Koli Adedi	Fiyat
109516	36W 60x60 S.Ü. 6500K	4	74,60 \$

Pelsan Clip-in Backlight Ofis Armatürleri

Clip-in Isoled
60x60





IP 40  ● 3000K ● 4000K ● 6500K

Lensli Modül

Kod No	Özellikler	Koli Adedi	Fiyat
111480	36W 60x60 Clip-in 4000K	6	39,70 \$
111481	36W 60x60 Clip-in 6500K	6	39,70 \$

Clip-in Isoled
30x30





IP 40  ● 3000K ● 4000K ● 6500K

Tarak PCB

Kod No	Özellikler	Koli Adedi	Fiyat
111582	12W 60x60 Clip-in 4000K	5	25,50 \$
111583	12W 60x60 Clip-in 6500K	5	25,50 \$

Clip-in Nora
60x60



IP 40  ● 3000K ● 4000K ● 6500K

Kod No	Özellikler	Koli Adedi	Fiyat
113791	36W 30x30 Clip-in 4000K	5	39,70 \$
113792	36W 30x30 Clip-in 6500K	5	39,70 \$

Clip-in Nora
30x30



IP 40  ● 3000K ● 4000K ● 6500K

Kod No	Özellikler	Koli Adedi	Fiyat
113783	12W 30x30 Clip-in 4000K	4	26,10 \$
113784	12W 30x30 Clip-in 6500K	4	26,10 \$

Clip-in Seoled 1
60x60



IP 40  ● 3000K ● 4000K ● 6500K

Kod No	Özellikler	Koli Adedi	Fiyat
109510	36W 60x60 Clip-in 4000K	5	75,60 \$
109511	36W 60x60 Clip-in 6500K	5	75,60 \$

Clip-in Seoled 2
60x60



IP 40  ● 3000K ● 4000K ● 6500K

Kod No	Özellikler	Koli Adedi	Fiyat
109512	36W 60x60 Clip-in 4000K	5	87,90 \$
109513	36W 60x60 Clip-in 6500K	5	87,90 \$

Clip-in IP54
60x60



IP 40  ● 3000K ● 4000K ● 6500K

Kod No	Özellikler	Koli Adedi	Fiyat
113261	36W 60x60 Clip-in 4000K	2	57,80 \$
113622	36W 60x60 Clip-in 6500K	2	57,80 \$

Clip-in IP54
30x30



IP 40  ● 3000K ● 4000K ● 6500K



Kod No	Özellikler	Koli Adedi	Fiyat
113657	12W 30x30 Clip-in 4000K	2	34,70 \$
113658	12W 30x30 Clip-in 6500K	2	34,70 \$

IP65 LED Steril
Sıva Altı Temperli Camlı



UGR<19

IP65

IP 65   

Kod No	Özellikler	Koli Adedi	Fiyat
110607	36W 60x60 S.A. 4000K IP65 Steril	2	127,50 \$
110608	36W 60x60 S.A. 6500K IP65 Steril	2	127,50 \$

Endirekt Steril
Sıva Altı 60x60

Yeni Ürün



IP65



IP 65   

Kod No	Özellikler	Koli Adedi	Fiyat
113438	36W 60x60 S.A. 4000K IP65	5	127,50 \$
113439	36W 60x60 S.A. 6500K IP65	5	127,50 \$

IP65 LED Steril
Sıva Altı Temperli Camlı



IP65

IP 65   

Kod No	Özellikler	Koli Adedi	Fiyat
109776	36W 60x60 S.A. 4000K IP65 Steril	2	95,50 \$
109777	36W 60x60 S.A. 6500K IP65 Steril	2	95,50 \$

IP65 LED Steril
Sıva Üstü Temperli Camlı







IP65

IP 65   

Kod No	Özellikler	Koli Adedi	Fiyat
109905	36W 60x60 IP65 4000K S.Ü. Steril	2	105,50 \$
109906	36W 60x60 IP65 6500K S.Ü. Steril	2	105,50 \$

IP54 LED Steril
Sıva Altı 60x60





IP 54   

Kod No	Özellikler	Koli Adedi	Fiyat
113288	36W 60x60 S.A. 4000K IP54 Steril	5	54,50 \$
113289	36W 60x60 S.A. 6500K IP54 Steril	5	54,50 \$

IP54 LED Steril
Sıva Altı 30x30





IP 54   

Kod No	Özellikler	Koli Adedi	Fiyat
111517	12W 30x30 S.A. 4000K IP54 Steril	5	31,40 \$
111518	12W 30x30 S.A. 6500K IP54 Steril	5	31,40 \$

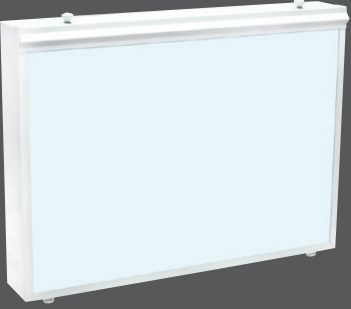
Negatoskop
Sıva Üstü





IP 40  

678mm 103mm 500mm

Kod No	Özellikler	Koli Adedi	Fiyat
106101	42W LED 60X60 S.Ü.6500K	1	181,50 \$

Negatoskop
Sıva Üstü



IP 40  

1200mm 103mm 500mm

Kod No	Özellikler	Koli Adedi	Fiyat
106103	84W LED 60X120 S.Ü.6500K	1	250,50 \$

Pelsan UGR Ofis Armatürleri

Isoled UGR Sıva Altı

Yeni Ürün



Mikro Prizmatik Difüzör

UGR<19

- Kamaşma önleyici difüzör
- +100lm/W verimlilik
- ENEC Belgeli Sürücü

IP 40 ● 3000K ● 4000K ● 6500K

Kod No	Özellikler	Koli Adedi	Fiyat
113538	36W 60x60 S.A. 4000K	6	42,70 \$
113539	36W 60x60 S.A. 6500K	6	42,70 \$

Nora UGR Sıva Altı 60x60



Kamaşma Önleyici Optik Tasarım

UGR<19

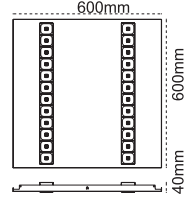

IP 40 ● 3000K ● 4000K ● 6500K

Kod No	Özellikler	Koli Adedi	Fiyat
113789	36W 60x60 S.A. 4000K RAL9005	5	34,20 \$
113790	36W 60x60 S.A. 6500K RAL9005	5	34,20 \$
113787	36W 60x60 S.A. 4000K RAL9016	5	34,20 \$
113788	36W 60x60 S.A. 6500K RAL9016	5	34,20 \$

Retto UGR Sıva Altı

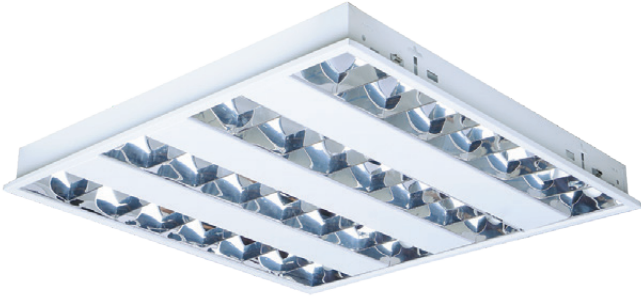

Kamaşma Önleyici Optik Tasarım

UGR<19

- Maksimum Görsel Konfor
- Alüminyum Reflektör
- +100lm/W

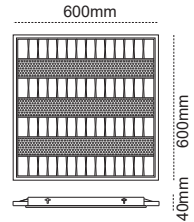

IP 40 ● 3000K ● 4000K ● 6500K

Kod No	Özellikler	Koli Adedi	Fiyat
109476	36W 60x60 S.A. 4000K	1	74,50 \$
113098	36W 60x60 S.A. 6500K	1	74,50 \$

Divaled Endirekt Sıva Altı / Sıva Üstü



Endirekt Aydınlatma

- Ultra Görsel Konfor
- Estetik Tasarım
- Soft Işık

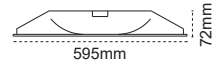

IP 40 ● 3000K ● 4000K ● 6500K

Kod No	Özellikler	Koli Adedi	Fiyat
108125	42W 60x60 S.A. 4000K	4	91,00 \$
108408	42W 60x60 S.A. 6500K	4	91,00 \$
110601	42W 60x60 S.Ü. 4000K	4	101,00 \$
110602	42W 60x60 S.Ü. 6500K	4	101,50 \$



**Kamaşma Önleyici
Optik Tasarım**

Nora UGR<19 Linear Sıva Üstü

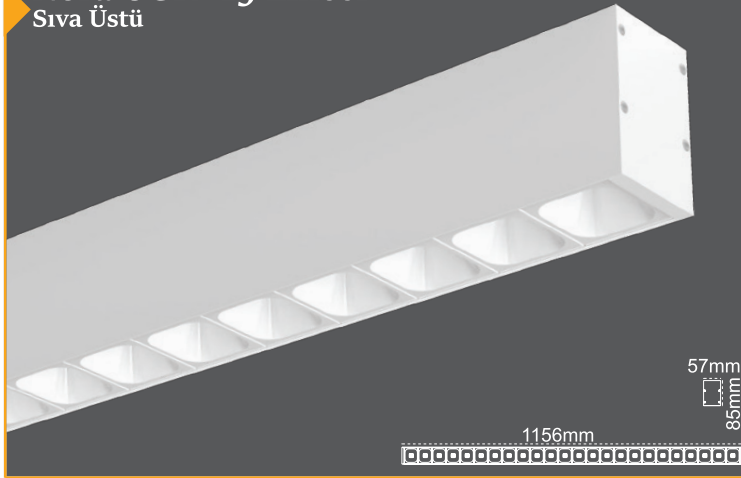

Sonsuz Linear Bağlantı

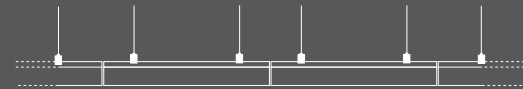

Tüm Tavan Tiplerine Uygun



IP 40  ● 3000K ● 4000K ● 6500K

Kod No	Özellikler	Koli Adedi	Fiyat
110674	14W 4000K 580mm	1	39,40 \$
110676	20W 4000K 865mm	1	51,80 \$
110678	28W 4000K 1150mm	1	63,10 \$
110681	42W 4000K 1435mm	1	84,40 \$



Nora UGR<16 Linear Sıva Üstü

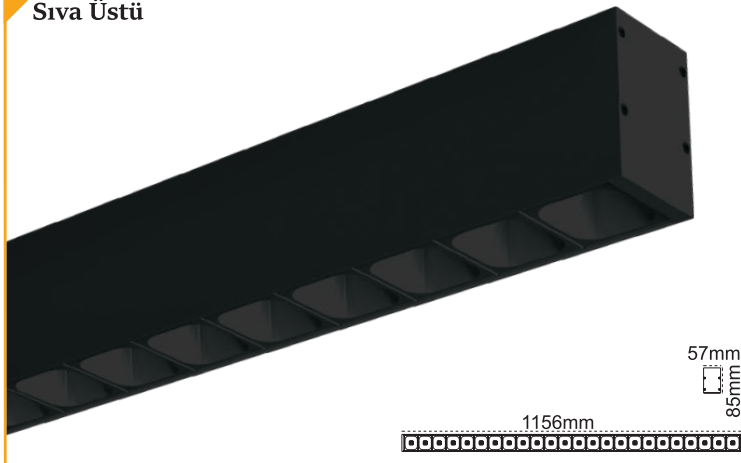

Sonsuz Linear Bağlantı

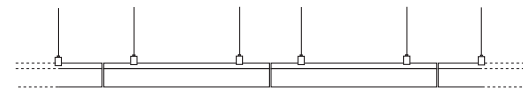

Tüm Tavan Tiplerine Uygun



IP 40  ● 3000K ● 4000K ● 6500K

Kod No	Özellikler	Koli Adedi	Fiyat
110673	14W 4000K 580mm	1	39,40 \$
110675	20W 4000K 865mm	1	51,80 \$
110677	28W 4000K 1150mm	1	63,10 \$
110680	42W 4000K 1435mm	1	84,40 \$



Opsiyon Farkları

Kod No	Özellikler	Koli Adedi	Fiyat
304906	Askı Aparatı 100 cm (2 adet)	1	4,30\$
304915	Askı Aparatı 150 cm (2 adet)	1	5,30\$
317986	Askı Rozans Takımı 150 cm Siyah (2 adet)	1	5,30\$
205224	Linear Birleştirme Aparatı Takımı (2 adet)	1	2,20\$

Pelsan Linear Armatürler

Eterna

Sonsuzluğa Uzanan Konforlu Aydınlatma



- LED Çip (LM80-TM218)
- ENEC Belgeli Sürücü
- Acil Aydınlatma
- DALI Opsiyonu

Sonsuz Linear Bağlantı



Bağlantı aparatları ile ürüne müdahale edilmeksizin dışardan kesintisiz linear bağlantı yapılır.

Tüm Tavan Tiplerine Uygun

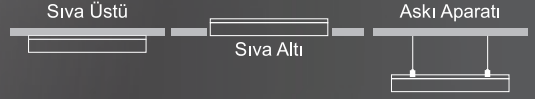

RAL 9005

RAL 9006

RAL 9016



Eterna (57mm) Sıva Üstü



IP 40 3000K 4000K 6500K

Kod No	Özellikler	Koli Adedi	Fiyat
108964	14W 4000K 600mm	1	39,40 \$
108965	20W 4000K 900mm	1	51,80 \$

IP 40 3000K 4000K 6500K

Kod No	Özellikler	Koli Adedi	Fiyat
108966	28W 4000K 1200mm	1	63,10 \$
108967	42W 4000K 1500mm	1	84,40 \$

Eterna (57mm) Sıva Altı

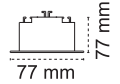
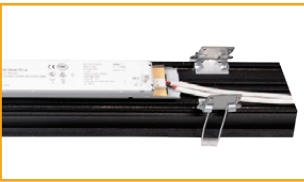

IP 20 3000K 4000K 6500K

Kod No	Özellikler	mm	Koli Adedi	Fiyat
108898	14W 4000K 640mm	625X62	1	39,40 \$
108899	20W 4000K 920mm	895X62	1	51,80 \$

IP 20 3000K 4000K 6500K

Kod No	Özellikler	mm	Koli Adedi	Fiyat
108900	28W 4000K 1240mm	1225X62	1	63,10 \$
108901	42W 4000K 1520mm	1505X62	1	84,40 \$

Opsiyon Farkları

Kod No	Özellikler	Koli Adedi	Fiyat
304906	Askı Aparatı 100 cm (2 adet)	1	4,30\$
304915	Askı Aparatı 150 cm (2 adet)	1	5,30\$
317986	Askı Rozans Takımı 150 cm Siyah (2 adet)	1	5,30\$
205224	Linear Birleştirme Aparatı Takımı (2 adet)	1	2,20\$

Trenta G2 (33mm)

CE

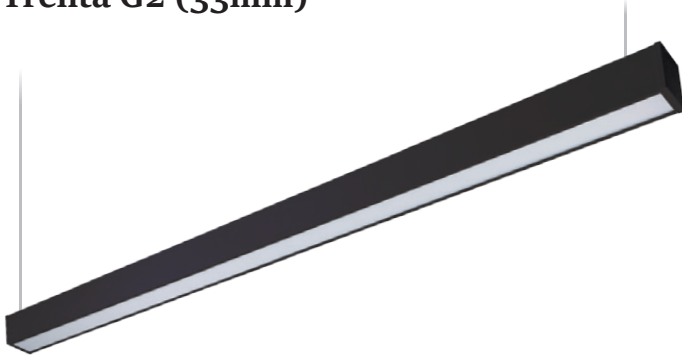

ŞOK FİYAT

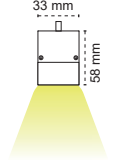

IP 40 ● 3000K ● 4000K ● 6500K

Kod No	Özellikler	Koli Adedi	Fiyat
113031	36W 4000K 1020mm	12	37,00 \$
113035	36W 4000K 1020mm Acil Aydınlatma Kitli	12	87,00 \$

Eterna Endirekt (47mm)

TSE

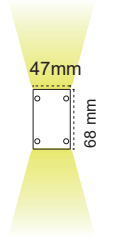
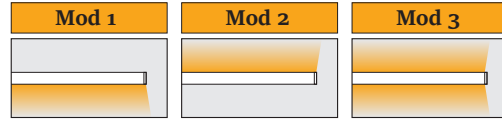

IP 40 ● 3000K ● 4000K ● 6500K

Kod No	Özellikler	Koli Adedi	Fiyat
206015	26W-16W 4000K 900mm	1	104,00 \$
206016	34W-18W 4000K 1200mm	1	114,90 \$
206017	44W-24W 4000K 1490mm	1	136,80 \$
206018	60W-40W 4000K 2000mm	1	191,50 \$

Trenta LED (33mm)
Sarkıt / Opal

TSE

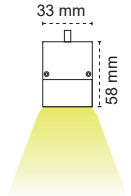
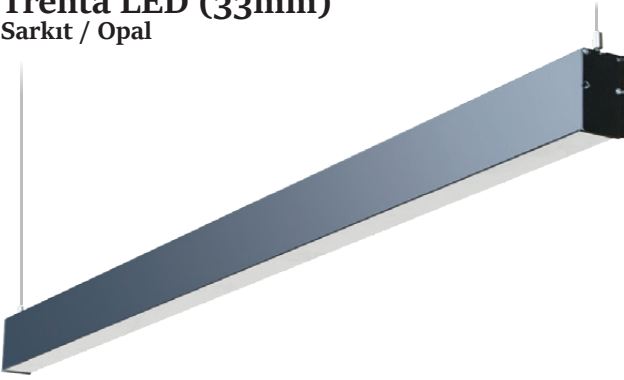

IP 40 ● 3000K ● 4000K ● 6500K

Kod No	Özellikler	Koli Adedi	Fiyat
111384	16W 4000K 590mm	12	43,80 \$
111385	32W 4000K 1200mm	12	62,90 \$
111386	42W 4000K 1500mm	12	71,10 \$
111387	56W 4000K 1980mm	1	93,00 \$

Sirenta LED (36mm)
Sarkıt / Opal

TSE

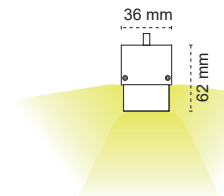
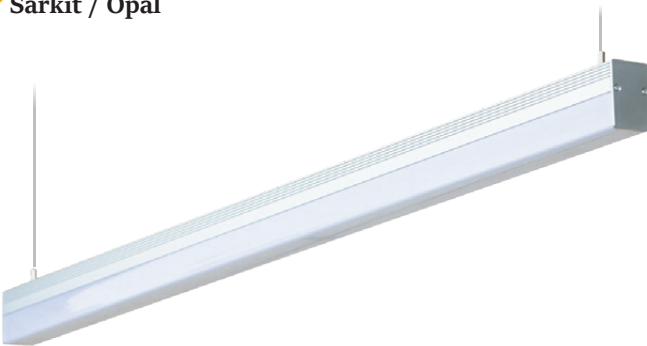

IP 40 ● 4000K ● 6500K

Kod No	Özellikler	Koli Adedi	Fiyat
107912	25W 4000K 1200mm	12	37,00 \$
102956	25W 6500K 1200mm	12	37,00 \$

● 1m askı aparatı dahildir.

Pelsan Mimari Armatürler

Circa

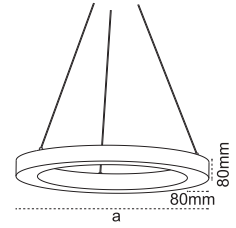
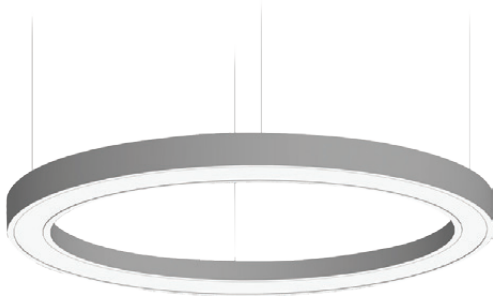

IP 40 ☺ ● 3000K ● 4000K ● 6500K

RAL 9005
RAL 9006
RAL 9016

Kod No	Özellikler	a	RAL	Koli Adedi	Fiyat
110125	32W 4000K	400mm	RAL 9006	1	82,10 \$
110126	50W 4000K	600mm	RAL 9006	1	109,40 \$
110127	75W 4000K	900mm	RAL 9006	1	177,80 \$
110128	100W 4000K	1200mm	RAL 9006	1	232,60 \$

Circa Triple

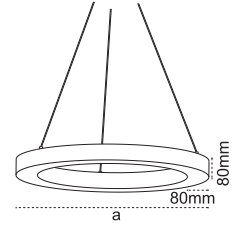
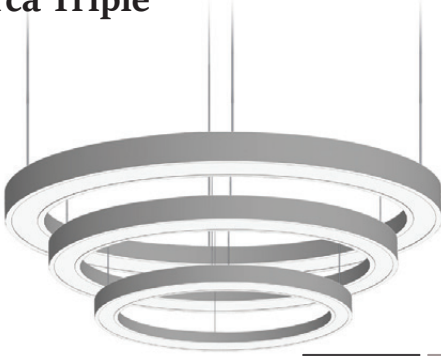

IP 40 ☺ ● 3000K ● 4000K ● 6500K

RAL 9005 RAL 9006 RAL 9016

Kod No	Özellikler	a	RAL	Koli Adedi	Fiyat
110125	32W 4000K	400mm	RAL 9006	1	82,10 \$
110126	50W 4000K	600mm	RAL 9006	1	109,40 \$
110127	75W 4000K	900mm	RAL 9006	1	177,80 \$
110128	100W 4000K	1200mm	RAL 9006	1	232,60 \$
321886	Circa-Polaris Askı Rozansı 3'lü		RAL 9006	1	41,00 \$

Polaris

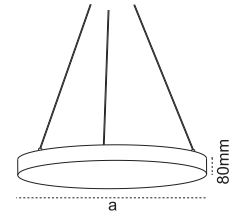

IP 40 ☺ ● 3000K ● 4000K ● 6500K

RAL 9005 RAL 9006 RAL 9016

Kod No	Özellikler	a	RAL	Koli Adedi	Fiyat
110129	36W 4000K	400mm	RAL 9006	1	82,10 \$
110130	50W 4000K	600mm	RAL 9006	1	131,30 \$
110131	100W 4000K	900mm	RAL 9006	1	218,90 \$

Della

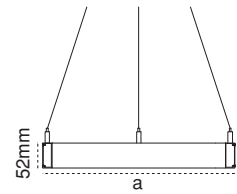
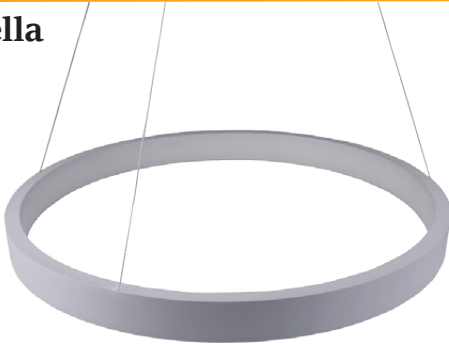

Yeni Ürün

IP 40 ☺ ● 3000K ● 4000K ● 6500K

● Askı aksesuarı dahil.

RAL 9005
RAL 9006
RAL 9016

Kod No	Özellikler	a	RAL	Koli Adedi	Fiyat
206426	20W 4000K	400mm	RAL 9006	1	136,80 \$
206432	30W 4000K	600mm	RAL 9006	1	177,80 \$
206438	40W 4000K	900mm	RAL 9006	1	232,60 \$
206444	60W 4000K	1200mm	RAL 9006	1	314,60 \$

Aksesuarlar

Kod No	Özellikler	Koli Adedi	Fiyat
321505	4'lü Askı Takımı 1,5 m RAL 9005	1	13,70 \$
321504	4'lü Askı Takımı 5 m RAL 9005	1	19,20 \$
321177	4'lü Askı Takımı 1,5 m RAL 9006	1	13,70 \$
321176	4'lü Askı Takımı 5 m RAL 9006	1	19,20 \$

Özellikler	Koli Adedi	Fiyat Farkı
Dali Farkı	1	31,25 \$

Quad

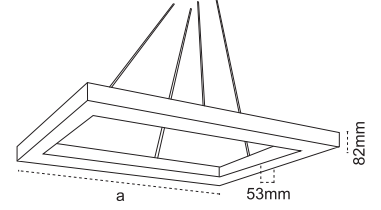
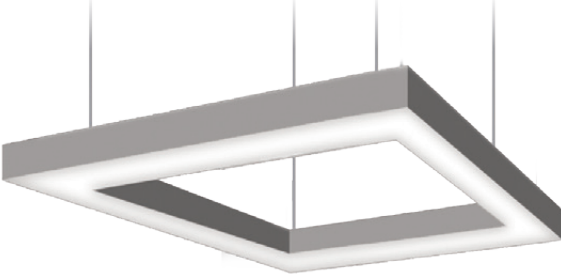

RAL 9005
RAL 9006
RAL 9016

IP 40 3000K 4000K 6500K

Kod No	Özellikler	Koli Adedi	Fiyat
110132	40W 4000K 420x420mm RAL 9006	1	109,40 \$
110133	60W 4000K 620x620mm RAL 9006	1	142,30 \$
110134	80W 4000K 920x920mm RAL 9006	1	224,30 \$

Detra

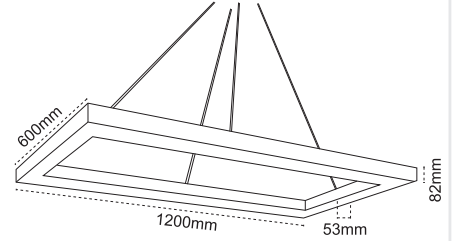

RAL 9005
RAL 9006
RAL 9016

IP 40 3000K 4000K 6500K

Kod No	Özellikler	Koli Adedi	Fiyat
110135	80W 4000K 600x1200 mm RAL 9006	1	224,30 \$

Norba

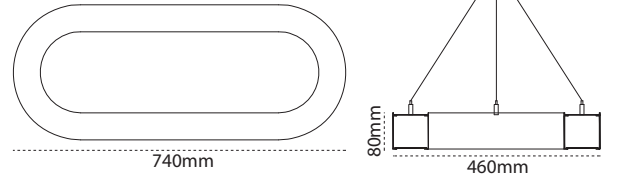

Yeni Ürün

RAL 9005
RAL 9006
RAL 9016

IP 40 3000K 4000K 6500K

Kod No	Özellikler	Koli Adedi	Fiyat
206474	50W 4000K 600mm RAL 9006	1	183,30 \$
206480	105W 4000K 900mm RAL 9006	1	259,90 \$

Tria

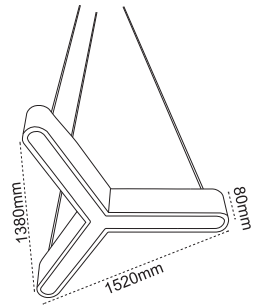
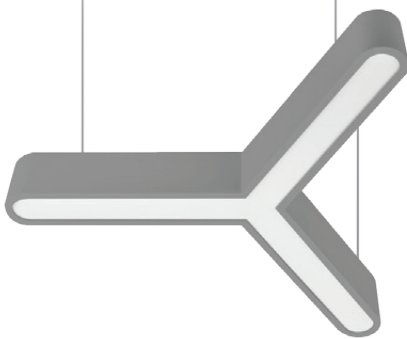

RAL 9005
RAL 9006
RAL 9016

IP 40 3000K 4000K 6500K

Kod No	Özellikler	Koli Adedi	Fiyat
109141	130W 4000K 1300x1500mm RAL 9006	1	232,60 \$

Aksesuarlar

Kod No	Özellikler	Koli Adedi	Fiyat
321505	4'lü Askı Takımı 1,5 m RAL 9005	1	13,70 \$
321504	4'lü Askı Takımı 5 m RAL 9005	1	19,20 \$
321177	4'lü Askı Takımı 1,5 m RAL 9006	1	13,70 \$
321176	4'lü Askı Takımı 5 m RAL 9006	1	19,20 \$

Özellikler	Koli Adedi	Fiyat Farkı
Dali Farkı	1	31,25 \$

Pelsan Mimari Armatürler

Smooth

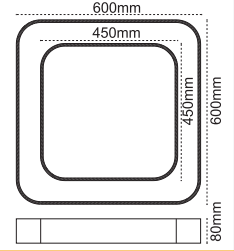
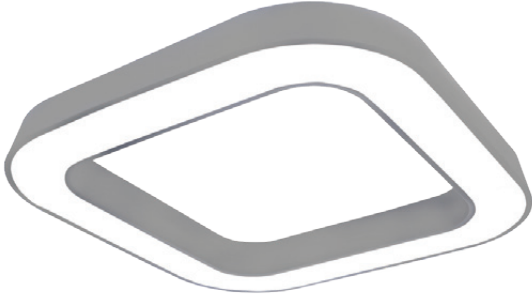

RAL 9005	IP 40	3000K	4000K	6500K		
RAL 9006	Kod No	Özellikler			Koli Adedi	Fiyat
RAL 9016	110268	50W 4000K	600mm	RAL 9005	1	164,20 \$
	110271	80W 4000K	900mm	RAL 9005	1	273,60 \$

Pieno

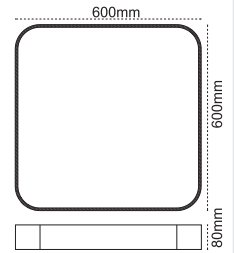
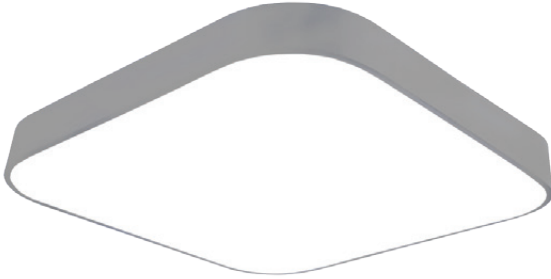

RAL 9005	IP 40	3000K	4000K	6500K		
RAL 9006	Kod No	Özellikler			Koli Adedi	Fiyat
RAL 9016	110274	50W 4000K	600mm	RAL 9005	1	218,90 \$
	110278	105W 4000K	900mm	RAL 9005	1	300,90 \$

Radia

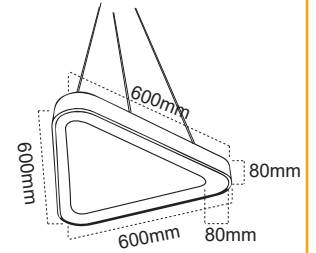
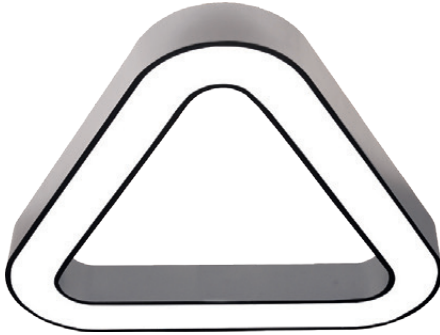

RAL 9005	IP 40	3000K	4000K	6500K		
RAL 9006	Kod No	Özellikler			Koli Adedi	Fiyat
RAL 9016	111148	30W 4000K 600x600x600mm	RAL 9006		1	150,50 \$

Yeni Ürün

Plena

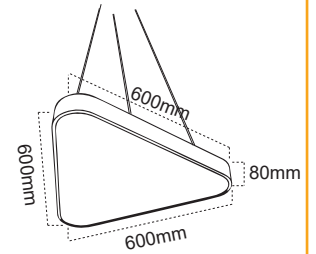

RAL 9005	IP 40	3000K	4000K	6500K		
RAL 9006	Kod No	Özellikler			Koli Adedi	Fiyat
RAL 9016	111152	45W 4000K 600x600x600mm	RAL 9006		1	177,80 \$

Yeni Ürün

Aksesuarlar

Kod No	Özellikler	Koli Adedi	Fiyat	Özellikler	Koli Adedi	Fiyat Farkı
321505	4'lü Askı Takımı 1,5 m RAL 9005	1	13,70 \$	Dali Farkı	1	31,25 \$
321504	4'lü Askı Takımı 5 m RAL 9005	1	19,20 \$			
321177	4'lü Askı Takımı 1,5 m RAL 9006	1	13,70 \$			
321176	4'lü Askı Takımı 5 m RAL 9006	1	19,20 \$			

Essa Yeni Ürün

RAL 9005
RAL 9006
RAL 9016

IP 40 ● 3000K ● 4000K ● 6500K

Kod No	Özellikler	Koli Adedi	Fiyat
206450	50W 4000K 600mm RAL9006	1	123,10 \$
206456	75W 4000K 900mm RAL9006	1	177,80 \$

Decora Yeni Ürün

RAL 9005
RAL 9006
RAL 9016

IP 20 ● 3000K ● 4000K ● 6500K ● Askı aksesuarı dahil.

Kod No	Özellikler	Koli Adedi	Fiyat
206344	75W 4000K RAL9005	1	213,40 \$

Hexa Yeni Ürün

RAL 9005
RAL 9006
RAL 9016

IP 40 ● 3000K ● 4000K ● 6500K

Kod No	Özellikler	Koli Adedi	Fiyat
206462	50W 4000K 600mm RAL9006	1	150,50 \$
206468	75W 4000K 900mm RAL9006	1	232,60 \$

Onda Yeni Ürün

RAL 9005
RAL 9006
RAL 9016

IP 20 ● 3000K ● 4000K ● 6500K ● Askı aksesuarı dahil.

Kod No	Özellikler	Koli Adedi	Fiyat
206338	27W 4000K RAL9005	1	80,70 \$

Twist Yeni Ürün

RAL 9005
RAL 9006
RAL 9016

IP 40 ● 3000K ● 4000K ● 6500K

Kod No	Özellikler	Koli Adedi	Fiyat
109130	45W 4000K 1500mm RAL9006	1	221,00 \$

Mento Yeni Ürün

RAL 9005
RAL 9006
RAL 9016

IP 20 ● 3000K ● 4000K ● 6500K ● Askı aksesuarı dahil.

Kod No	Özellikler	Koli Adedi	Fiyat
206338	27W 4000K RAL9005	1	82,10 \$

Aksesuarlar

Kod No	Özellikler	Koli Adedi	Fiyat
321505	4'lü Askı Takımı 1,5 m RAL 9005	1	13,70 \$
321504	4'lü Askı Takımı 5 m RAL 9005	1	19,20 \$
321177	4'lü Askı Takımı 1,5 m RAL 9006	1	13,70 \$
321176	4'lü Askı Takımı 5 m RAL 9006	1	19,20 \$

Özellikler	Koli Adedi	Fiyat Farkı
Dali Farkı	1	31,25 \$

Pelsan Dekoratif Sarkıt Armatürleri

Pyramid



IP 20 ⊕

Kod No	Özellikler	Koli Adedi	Fiyat
109580	E27 Siyah	10	17,50 \$

Ring



IP 20 ⊕

Kod No	Özellikler	Koli Adedi	Fiyat
109581	E27 Siyah	10	17,50 \$

Diamond



IP 20 ⊕

Kod No	Özellikler	Koli Adedi	Fiyat
109582	E27 Siyah	10	17,50 \$

Pico



IP 20 ⊕

Kod No	Özellikler	Koli Adedi	Fiyat
103782	E27 Siyah	4	14,80 \$

Pico



IP 20 ⊕

Kod No	Özellikler	Koli Adedi	Fiyat
103781	E27 Beyaz	4	14,80 \$

Simi



IP 20 ⊕

Kod No	Özellikler	Koli Adedi	Fiyat
108972	E27 Beyaz	4	14,80 \$

Rodos



IP 20 ⊕

Kod No	Özellikler	Koli Adedi	Fiyat
103776	E27 Siyah	4	25,90 \$

Rodos



IP 20 ⊕

Kod No	Özellikler	Koli Adedi	Fiyat
103775	E27 Beyaz	4	25,90 \$

Avsha

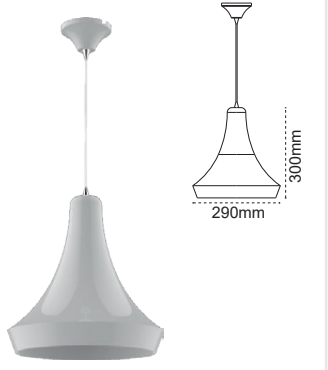

IP 20 ⊕

Kod No	Özellikler	Koli Adedi	Fiyat
103774	E27 Gri	4	25,90 \$

Volga



IP 20 ⊕

Kod No	Özellikler	Koli Adedi	Fiyat
104235	E27 Gümüş	6	32,30 \$
106638	50W 4000K LED Gümüş	6	44,30 \$

Volga

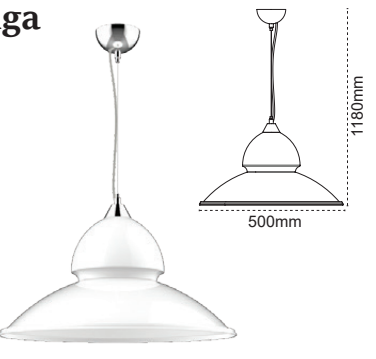

IP 20 ⊕

Kod No	Özellikler	Koli Adedi	Fiyat
104236	E27 Beyaz	6	32,30 \$
106641	50W 4000K LED Beyaz	6	44,30 \$

Avsha





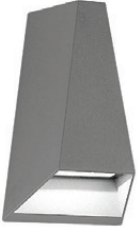
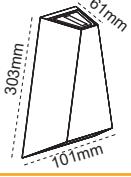
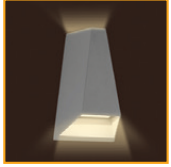

IP 20 ⊕

Kod No	Özellikler	Koli Adedi	Fiyat
103773	E27 Siyah	4	18,50 \$



Cono



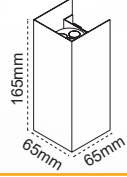

IP 20   3000K  4000K  6500K

Kod No	Özellikler	Koli Adedi	Fiyat
106049	6W 3000K	6	30,90 \$



Rodin



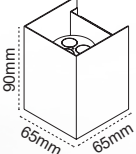
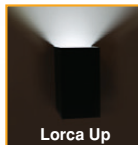

IP 20 

Kod No	Özellikler	Koli Adedi	Fiyat
111116	2xGu10 Duylu	12	11,40 \$



Lorca - Up / Down







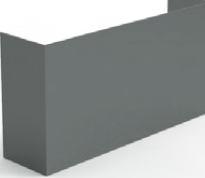
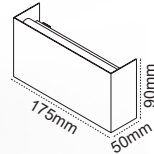

IP 20 

Kod No	Özellikler	Koli Adedi	Fiyat
111118	1xGu10 Duylu	12	9,80 \$
113081	1xGu10 Duylu	12	9,80 \$



Landi







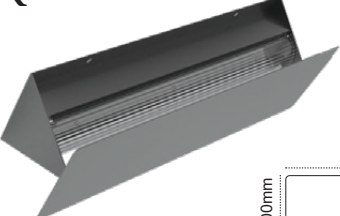
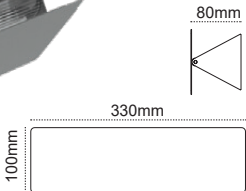

IP 20   3000K  4000K  6500K

Kod No	Özellikler	Koli Adedi	Fiyat
111390	7W 4000K	12	41,70 \$

Quinn









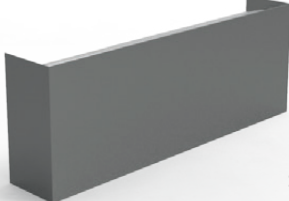
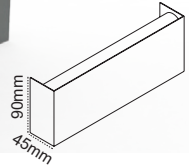

IP 20   3000K  4000K  6500K

Açı Ayarlanabilir

Kod No	Özellikler	Koli Adedi	Fiyat
111389	10W 4000K	12	42,60 \$

Diaz







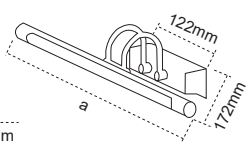

IP 20   3000K  4000K  6500K

Kod No	Özellikler	Koli Adedi	Fiyat
111391	10W 4000K	12	47,70 \$

Da Vinci Krom







 Krom
 Gold
 Siyah

IP 40   4000K

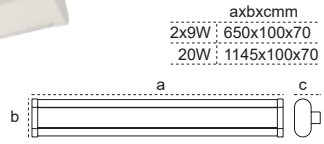
Kod No	Özellikler	Koli Adedi	Fiyat
206276	6W 4000K 350mm	12	22,00 \$
206277	9W 4000K 500mm	12	28,70 \$

Vogel





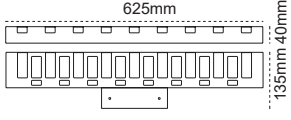

IP 40   4000K  6500K

Kod No	Özellikler	Koli Adedi	Fiyat
109541	20W 4000K LED	10	42,10 \$
109542	2x9W 6500K LED Tube Lambalı	10	19,00 \$

Otto

IP 40   4000K  6500K

Kod No	Özellikler	Koli Adedi	Fiyat
109539	10W 4000K LED	10	45,80 \$
109540	9W 6500K LED Tube Lambalı	10	28,70 \$

Dali

Anahtarlı

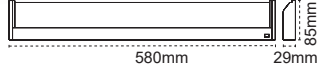
Alüminyum Gövde

IP 40 

Kod No	Özellikler	Koli Adedi	Fiyat
204547	6W 4000K	12	33,00 \$

Pelsan Downlight Armatürler



Tira Yuvarlak

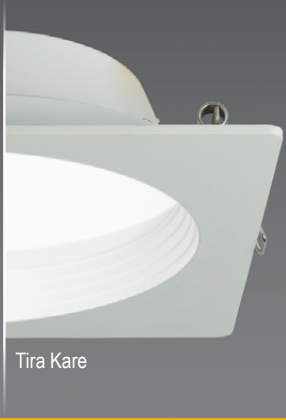

Tira Kare

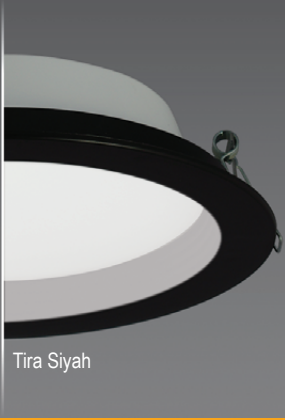

Tira Siyah



Tira IP54



Rina Sıva Üstü

Her Mekana Uygun Bir Tira Armatür Mutlaka Vardır!



3 Farklı Boy
9 Farklı Güç



Tira Alüminyum Enj. 4" Sıva Altı

IP 40 ☺ ● 3000K ● 4000K ● 6500K

Kod No	Özellikler	Ø mm	Koli Adedi	Fiyat
109708	12W 4000K	132	20	21,30 \$
109721	20W 4000K	132	20	22,30 \$

Tira Alüminyum Enj. 4" Sıva Altı

IP 40 ☺ ● 3000K ● 4000K ● 6500K

Kod No	Özellikler	Ø mm	Koli Adedi	Fiyat
109714	12W 4000K	132	20	21,30 \$
109725	20W 4000K	132	20	22,30 \$

Tira Alüminyum Enj. 6" Sıva Altı

IP 40 ☺ ● 3000K ● 4000K ● 6500K

Kod No	Özellikler	Ø mm	Koli Adedi	Fiyat
109158	12W 4000K	185	15	28,00 \$
109163	24W 4000K	185	15	28,50 \$
109165	36W 4000K	185	15	33,00 \$

Tira Alüminyum Enj. 6" Sıva Altı

IP 40 ☺ ● 3000K ● 4000K ● 6500K

Kod No	Özellikler	Ø mm	Koli Adedi	Fiyat
109159	12W 4000K	185	15	28,00 \$
109164	24W 4000K	185	15	28,50 \$
109166	36W 4000K	185	15	33,00 \$

Rina Alüminyum 4" Sıva Üstü

IP 40 ☺ ● 3000K ● 4000K ● 6500K

RAL 9005
RAL 9006
RAL 9016

Kod No	Özellikler	Koli Adedi	Fiyat
110599	12W 4000K	24	27,70 \$

Rina Alüminyum 6" Sıva Üstü

IP 40 ☺ ● 3000K ● 4000K ● 6500K

RAL 9005
RAL 9006
RAL 9016

Kod No	Özellikler	Koli Adedi	Fiyat
110600	24W 4000K	16	35,10 \$

Tira Beyaz 4"



Kare Opsiyonu



Siyah Opsiyonu

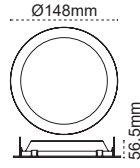

IP 40 ● 3000K ● 4000K ● 6500K

Kod No	Özellikler	Ø mm	Koli Adedi	Fiyat
106928	5W 4000K	132	20	22,30 \$
106934	7W 4000K	132	20	23,20 \$
106937	10W 4000K	132	20	24,10 \$

Tira IP54 4"



IP54

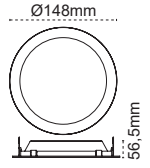

IP 54 ● 3000K ● 4000K ● 6500K

Kod No	Özellikler	Ø mm	Koli Adedi	Fiyat
107069	7W 4000K	132	20	28,20 \$
107072	10W 4000K	132	20	29,10 \$

Tira Beyaz 6"



Kare Opsiyonu



Siyah Opsiyonu

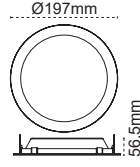

IP 40 ● 3000K ● 4000K ● 6500K

Kod No	Özellikler	Ø mm	Koli Adedi	Fiyat
106943	10W 4000K	185	15	24,10 \$
106950	15W 4000K	185	15	27,80 \$
106961	20W 4000K	185	15	31,50 \$

Tira IP54 6"



IP54

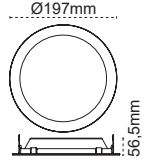

IP 54 ● 3000K ● 4000K ● 6500K

Kod No	Özellikler	Ø mm	Koli Adedi	Fiyat
107075	15W 4000K	220	10	33,80 \$
107078	20W 4000K	220	10	37,50 \$

Tira Beyaz 8"



Kare Opsiyonu



Siyah Opsiyonu

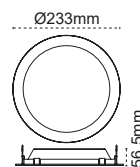

IP 40 ● 3000K ● 4000K ● 6500K

Kod No	Özellikler	Ø mm	Koli Adedi	Fiyat
106969	20W 4000K	220	10	38,90 \$
106977	25W 4000K	220	10	46,30 \$
106985	35W 4000K	220	10	53,70 \$

Tira IP54 8"



IP54

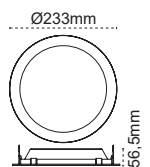

IP 54 ● 3000K ● 4000K ● 6500K

Kod No	Özellikler	Ø mm	Koli Adedi	Fiyat
107081	25W 4000K	220	10	52,30 \$
107084	35W 4000K	220	10	59,20 \$

Pelsan Yeni Downlight Armatürler

Dore



TSE Belgeli



Slim
Tasarım



134 lm/W'a
Varan Verimlilik



ENEC Belgeli
Sürücü



+50.000h
LED Ömrü

Dore Sıva Altı



Øxhmm	Ø	h
7W 120x45		
10-13W 170x45		
18-22W 225x45		

Yeni Ürün



5
YIL
GARANTİ

134lm/W'a
Varan Verimlilik

IP 40 3000K 4000K 6500K

Kod No	Özellikler	Ø mm	Koli Adedi	Fiyat
110864	7W 4000K	105	30	11,10 \$
110865	10W 4000K	155	30	14,00 \$
110866	13W 4000K	155	30	15,90 \$
110867	18W 4000K	205	20	20,90 \$
110868	22W 4000K	205	20	22,20 \$

Dore Sıva Üstü

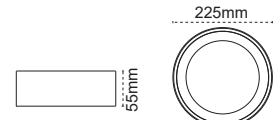

IP 40 3000K 4000K 6500K

Kod No	Özellikler	Koli Adedi	Fiyat
111752	18W 4000K	30	24,90 \$
111755	22W 4000K	30	26,20 \$
111759	22W 4000K Acil Aydınlatma Kiti	24	6,20 \$

Opsiyon Farkları

Kod No	Özellikler	Koli Adedi	Fiyat
313118	Acil Aydınlatma Kiti (1 saat)	1	26,00 \$
316611	Acil Aydınlatma Kiti (3 saat)	1	30,30 \$

Slim Backlight Downlight Armatürler **Pelsan**

Sırma

Birebir
Değişim Garantisi



Slim
Tasarım



Backlight
Işık Konforu



Dahili
Sürücü



Acil Kit
Uygulaması

Sırma 6W

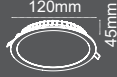

IP 40 ● 3000K ● 4000K ● 6500K

Kod No	Özellikler	Ø mm	Koli Adedi	Fiyat
110330	6W 3000K	105	20	4,30 \$
110331	6W 4000K	105	20	4,30 \$
110332	6W 6500K	105	20	4,30 \$

Sırma 9W

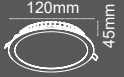

IP 40 ● 3000K ● 4000K ● 6500K

Kod No	Özellikler	Ø mm	Koli Adedi	Fiyat
110333	9W 3000K	105	20	5,70 \$
110334	9W 4000K	105	20	5,70 \$
110335	9W 6500K	105	20	5,70 \$

Sırma 12W

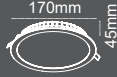

IP 40 ● 3000K ● 4000K ● 6500K

Kod No	Özellikler	Ø mm	Koli Adedi	Fiyat
110339	12W 3000K	155	15	6,80 \$
110340	12W 4000K	155	15	6,80 \$
110341	12W 6500K	155	15	6,80 \$

Sırma 15W



IP 40 ● 3000K ● 4000K ● 6500K

Kod No	Özellikler	Ø mm	Koli Adedi	Fiyat
110342	15W 3000K	155	15	8,50 \$
110343	15W 4000K	155	15	8,50 \$
110344	15W 6500K	155	15	8,50 \$

Sırma 18W



IP 40 ● 3000K ● 4000K ● 6500K

Kod No	Özellikler	Ø mm	Koli Adedi	Fiyat
110348	18W 3000K	205	10	9,80 \$
110349	18W 4000K	205	10	9,80 \$
110350	18W 6500K	205	10	9,80 \$

Sırma Sıva Üstü



IP 40 ● 3000K ● 4000K ● 6500K

Kod No	Özellikler	Koli Adedi	Fiyat
111748	18W 3000K	25	13,80 \$
111749	18W 4000K	25	13,80 \$
111750	18W 6500K	25	13,80 \$

Opsiyon Farkları

Kod No	Özellikler	Koli Adedi	Fiyat
313117	Acil Aydınlatma Kiti (1 saat)	1	26,00 \$

Pelsan LED Spotlar

Capella & Spica

Sıva Altı / Sıva Üstü

Yeni Ürün

RAL 9005

RAL 9016



Capella



Sıva Üstü



74mm



Spica



74mm



Spica



55x155mm

Kod No	Özellikler	Koli Adedi	Fiyat
110624	8W 4000K Sıva Altı	8	36,00 \$
110625	8W 4000K Sıva Üstü	8	37,60 \$
110626	1xGu10 Sıva Altı	8	19,40 \$

Kod No	Özellikler	Koli Adedi	Fiyat
110640	1x8W 4000K Sıva Altı	1	28,20 \$
110643	1x8W 4000K Sıva Üstü	1	31,30 \$
110641	1xGu10 Sıva Altı	1	19,40 \$
110642	1xGu10 Sıva Üstü	1	22,50 \$

Kod No	Özellikler	Koli Adedi	Fiyat
110644	2x8W 4000K Sıva Altı	1	47,60 \$
110647	2x8W 4000K Sıva Üstü	1	53,80 \$
110646	2xGu10 Sıva Altı	1	37,60 \$
110645	2xGu10 Sıva Üstü	1	43,80 \$

Lora

Sıva Altı

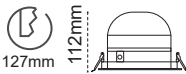

127mm

112mm

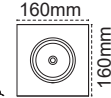

160mm

160mm

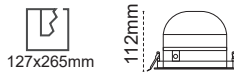

127x265mm

112mm

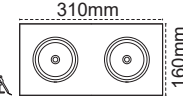

310mm

160mm



127x420mm

112mm

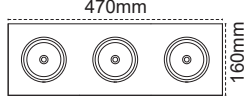

470mm

160mm

Kod No	Özellikler	Koli Adedi	Fiyat
110557	20W 4000K	8	40,60 \$
110545	30W 4000K	8	44,30 \$

Kod No	Özellikler	Koli Adedi	Fiyat
110558	2x20W 4000K	4	76,60 \$
110546	2x30W 4000K	4	80,30 \$

Kod No	Özellikler	Koli Adedi	Fiyat
110559	3x20W 4000K	3	122,80 \$
110547	3x30W 4000K	3	126,50 \$

Lora

Sıva Üstü

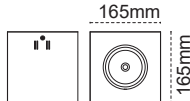

165mm

165mm

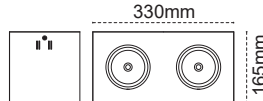

330mm

165mm

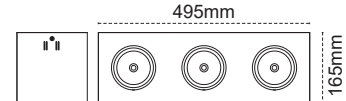

495mm

165mm

Kod No	Özellikler	Koli Adedi	Fiyat
110548	20W 4000K	8	52,60 \$
110422	30W 4000K	8	56,30 \$

Kod No	Özellikler	Koli Adedi	Fiyat
110549	2x20W 4000K	4	99,70 \$
110537	2x30W 4000K	4	103,40 \$

Kod No	Özellikler	Koli Adedi	Fiyat
110550	3x20W 4000K	3	138,50 \$
110538	3x30W 4000K	3	142,20 \$

Nira Siyah



Ø190



172mm



154mm

Kod No	Özellikler	Koli Adedi	Fiyat
108140	30W 4000K	12	52,30 \$

Nira Beyaz



Ø190



172mm



154mm

Kod No	Özellikler	Koli Adedi	Fiyat
107904	30W 4000K	12	52,30 \$

Bella & Stella



kendi ürününü tasarla...

Ürün Tipi	Güç[W]	Duy	Gövde Rengi	Reflektör Rengi	Dış Çap [mm]	Kesim Çapı[mm]	Koli Adedi	Fiyat
	206258	GU10	Siyah	Beyaz	95	80	36	2,90 \$
	205784			Siyah	95	80	36	
	205787			Gold	95	80	36	
	205790			Platin	95	80	36	
	205793			Rose	95	80	36	
	205832	GU10	Beyaz	Beyaz	95	80	36	2,90 \$
	206259			Siyah	95	80	36	
	205835			Gold	95	80	36	
	205838			Platin	95	80	36	
	205841			Rose	95	80	36	
	206260	GU10	Siyah	Beyaz	90x90	80	36	2,90 \$
	205880			Siyah	90x90	80	36	
	205883			Gold	90x90	80	36	
	205886			Platin	90x90	80	36	
	205889			Rose	90x90	80	36	
	205928	GU10	Beyaz	Beyaz	90x90	80	36	2,90 \$
	206261			Siyah	90x90	80	36	
	205931			Gold	90x90	80	36	
	205934			Platin	90x90	80	36	
	205937			Rose	90x90	80	36	
	206262	GU10	Siyah	Beyaz	80x105	-	18	13,20 \$
	205808			Siyah	80x105	-	18	
	205811			Gold	80x105	-	18	
	205814			Platin	80x105	-	18	
	205817			Rose	80x105	-	18	
	205844	GU10	Beyaz	Beyaz	80x105	-	18	13,20 \$
	206263			Siyah	80x105	-	18	
	205847			Gold	80x105	-	18	
	205850			Platin	80x105	-	18	
	205853			Rose	80x105	-	18	
	206664	GU10	Siyah	Beyaz	75x75x105	-	1	16,10 \$
	205892			Siyah	75x75x106	-	18	
	205895			Gold	75x75x107	-	18	
	205898			Platin	75x75x108	-	18	
	205901			Rose	75x75x109	-	18	
	205940	GU10	Beyaz	Beyaz	75x75x110	-	18	16,10 \$
	206265			Siyah	75x75x111	-	18	
	205943			Gold	75x75x112	-	18	
	205946			Platin	75x75x113	-	18	
	205949			Rose	75x75x114	-	18	

Pelsan LED Ray Spotlar

Theta Monofaz



ENEC Belgeli Sürücü



Alüminyum Enjeksiyon Gövde



CRI>80 ile Daha Canlı Renkler



Işığı Yönlendiren Tasarım (270C° / 360C°)

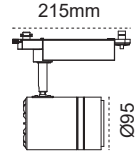

IP 40

Kod No	Özellikler	Koli Adedi	Fiyat
107982	30W COB LED 3000K	16	26,90 \$
107981	30W COB LED 4000K	16	26,90 \$

Zeta

Yeni Ürün



Siyah



Beyaz

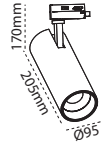

IP 40 3000K 4000K 6500K

Kod No	Özellikler	Koli Adedi	Fiyat
206499	20W 3000K	12	47,80 \$
206503	30W 3000K	12	48,30 \$
206507	40W 3000K	12	48,80 \$

Beta

Yeni Ürün



Siyah



Beyaz

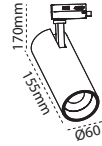

IP 40 3000K 4000K 6500K

Kod No	Özellikler	Koli Adedi	Fiyat
206512	10W 3000K	12	36,10 \$

Omega

Yeni Ürün



Siyah



Beyaz

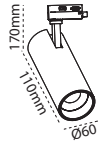

IP 40

Kod No	Özellikler	Koli Adedi	Fiyat
206514	GU10 Siyah	12	26,80 \$
206515	GU10 Beyaz	12	26,80 \$

Monofaz Ray ve Aksesuarları



I Bağlantı



T Bağlantı



L Bağlantı

Siyah Monofaz Ray ve Aksesuarları

Beyaz Monofaz Ray ve Aksesuarları

Kod No	Özellikler	Koli Adedi	Fiyat
303845	Tek Fazlı Ray 1 Metre Siyah	1	7,20 \$
303846	Tek Fazlı Ray 2 Metre Siyah	1	14,40 \$
303847	Tek Fazlı Ray 3 Metre Siyah	1	21,60 \$
303848	Tek Fazlı Ray L Bağlantı Parçası Siyah	1	3,90 \$
303849	Tek Fazlı Ray T Bağlantı Parçası Siyah	1	6,00 \$
316066	Tek Fazlı Ray X Bağlantı Parçası Siyah	1	6,70 \$
303835	Tek Fazlı Ray I Bağlantı Parçası Siyah	1	3,10 \$
316067	Tek Fazlı Ray Son Parça - Siyah	1	3,20 \$

Kod No	Özellikler	Koli Adedi	Fiyat
303839	Tek Fazlı Ray 1 Metre Beyaz	1	7,20 \$
303840	Tek Fazlı Ray 2 Metre Beyaz	1	14,40 \$
303841	Tek Fazlı Ray 3 Metre Beyaz	1	21,60 \$
303842	Tek Fazlı Ray L Bağlantı Parçası Beyaz	1	3,90 \$
303843	Tek Fazlı Ray T Bağlantı Parçası Beyaz	1	6,00 \$
316068	Tek Fazlı Ray X Bağlantı Parçası Beyaz	1	6,70 \$
303844	Tek Fazlı Ray I Bağlantı Parçası Beyaz	1	3,10 \$
316069	Tek Fazlı Ray Son Parça - Beyaz	1	3,20 \$

Pio



Ø250mm



IP 40  ● 4000K ● 6500K

Kod No	Özellikler	Koli Adedi	Fiyat
108555	16W 4000K	9	9,20 \$
105395	16W 6500K	9	9,20 \$



Ø350mm

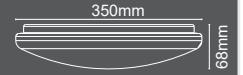

IP 40  ● 4000K ● 6500K

Kod No	Özellikler	Koli Adedi	Fiyat
107950	24W 4000K	10	16,80 \$
107951	24W 6500K	10	16,80 \$
107952	2x24W Dinamik Beyaz	10	25,50 \$

Pio



∅ 250mm

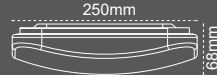

IP 40  ● 4000K ● 6500K

Kod No	Özellikler	Koli Adedi	Fiyat
105393	16W 6500K	10	10,20 \$



∅ 350mm



IP 40  ● 4000K ● 6500K

Kod No	Özellikler	Koli Adedi	Fiyat
107954	24W 6500K	10	25,50 \$
107956	2x24W Dinamik Beyaz	10	25,50 \$

Punto

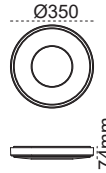

IP 40  ● 4000K ● 6500K

Kod No	Özellikler	Koli Adedi	Fiyat
111306	24W Yuvarlak 6500K	10	29,20 \$
111307	24W Yuvarlak 6500K Radar Sensör	10	45,70 \$
111308	2x24W Yuvarlak Dinamik Beyaz	10	29,10 \$

Punto

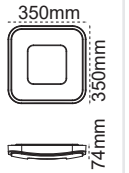

IP 40  ● 4000K ● 6500K

Kod No	Özellikler	Koli Adedi	Fiyat
111309	24W Kare 6500K	10	29,20 \$
111310	24W Kare 6500K Radar Sensör	10	45,70 \$
111311	2x24W Kare Dinamik Beyaz	10	29,10 \$

Picto

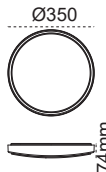

IP 40  ● 4000K ● 6500K

Kod No	Özellikler	Koli Adedi	Fiyat
111312	24W Yuvarlak 6500K	10	27,60 \$
111313	2x24W Yuvarlak Dinamik Beyaz	10	27,60 \$

Picto

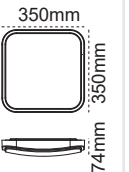

IP 40  ● 4000K ● 6500K

Kod No	Özellikler	Koli Adedi	Fiyat
111314	24W Kare 6500K	10	27,60 \$
111315	2x24W Kare Dinamik Beyaz	10	27,60 \$

Pelsan Sensörlü Armatürler

Sense



Işık Tam Zamanında Yansın!

- Time butonu ile lambanın ne kadar süreyle yanacağı
- Sens butonu ile lambanın ne kadar mesafeden hareketi algılayıp yanacağı ayarlanabilir.
- (-) işareti yükün yalnızca gece (+) işareti gündüz ve gece açık olacağını belirtir.
- Max.montaj yüksekliği 4.5m'di



min.2.5m



Sensörlü (2xE27)

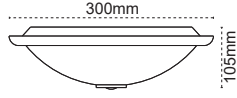

IP 20

Kod No	Özellikler	Koli Adedi	Fiyat
110695	2xE27	10	7,00 \$
110917	2XE27 Sensörlü	10	12,75 \$

Acil Sensörlü (2xE27)

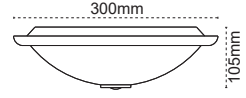

IP 20

Kod No	Özellikler	Koli Adedi	Fiyat
110697	2xE27 Sensörlü + Acil Ayd.	10	15,70 \$

LED'li Sensörlü

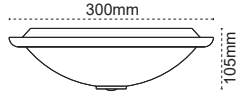

IP 20

Kod No	Özellikler	Koli Adedi	Fiyat
110696	8W LED 6500K Sensörlü	10	13,60 \$

Acil LED'li Sensörlü

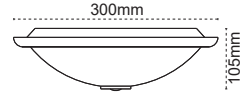

IP 20

Kod No	Özellikler	Koli Adedi	Fiyat
104369	8W LED 6500K Sens.+ Acil Ayd.	10	19,90 \$

Sensörlü 30x30 Sıva Üstü

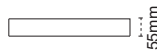

IP 40 4000K 6500K

Kod No	Özellikler	Koli Adedi	Fiyat
108780	12W 6500K Radar Sens.	5	40,50 \$
109086	12W 6500K Radar Sens. + Acil Ayd. Kit	5	66,50 \$

Kolay Sense

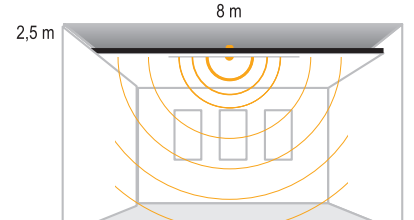

Zaman ve Lux ayarlama özelliği ile sıva üstü uygulamalar için ideal çözüm

Kod No	Özellikler	Koli Adedi	Fiyat
109227	E27 Duyulu Sensör	50	5,50 \$

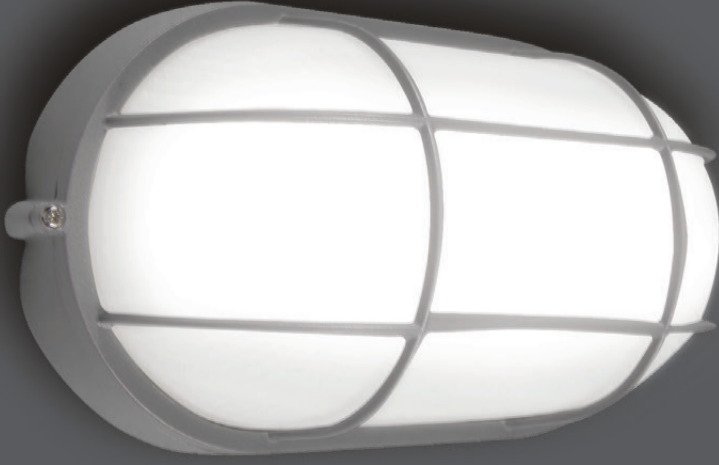

Alüminyum Enjeksiyon Gövde



IP54 Harici Armatür



E27 Duyulu

IP54 Oval Kafes Alüminyum Enjeksiyon

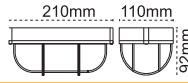

IP 54

Kod No

204487

Özellikler

E27 Duyulu

Koli Adedi

18

Fiyat

9,90 \$



Mova Aplik

Yeni Ürün

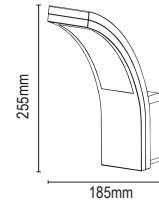

IP 54

Kod No

111603

Özellikler

10W 4000K

Koli Adedi

6

Fiyat

21,20 \$

Mova Aplik Sensör

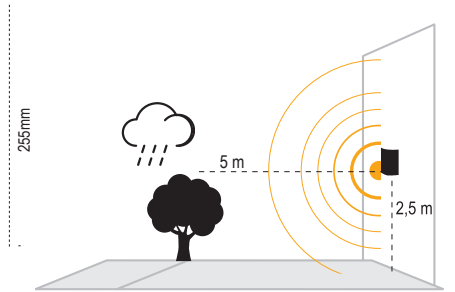

IP 54

Kod No

110324

Özellikler

10W 4000K Sensör

Koli Adedi

6

Fiyat

28,50 \$

Mova Aplik Sensörlü

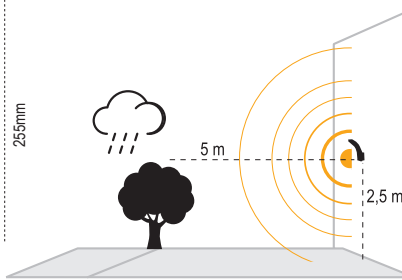

IP 54

Kod No

109228

Özellikler

10W 6500K

Koli Adedi

6

Fiyat

28,50 \$

Işıközü Sensörlü

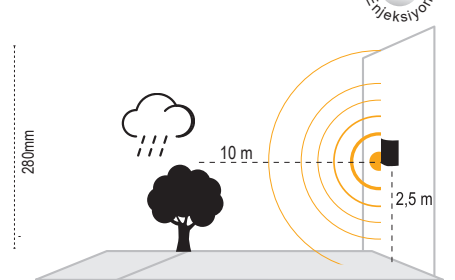

IP 44

Kod No

109297

Özellikler

2xE27 Duyulu

Koli Adedi

6

Fiyat

27,10 \$



Pelsan IP66 Tavan / Duvar Armatürleri



**Vidasız Çerçeve ile
Mükemmel Görünüm**



**Yeni*
Havana**

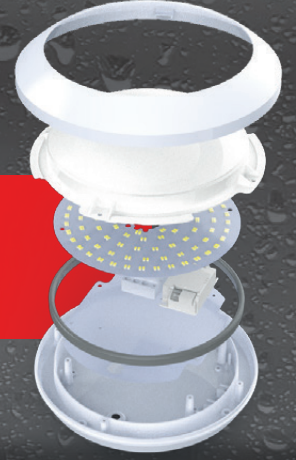

Daha Kolay Montaj



Kitli + Radar Sensörlü



IP66 Su ve Toz Almaz!

Havana G2 - E27 Duylu IP66

- BEYAZ
- GRİ
- SİYAH

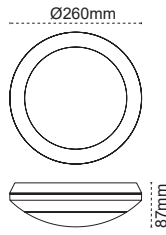
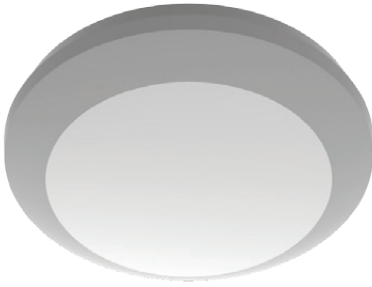

IP 66 3000K 4000K 6500K

Kod No	Özellikler	Koli Adedi	Fiyat
111193	E27	8	16,50 \$
111194	2XE27	8	17,60 \$
111220	E27 Sensör	8	30,50 \$
111223	2XE27 Sensör	8	31,60 \$



Havana G2 - LED - ENEC Driver IP66

- BEYAZ
- GRİ
- SİYAH

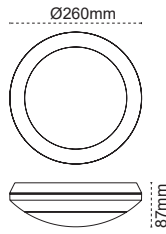
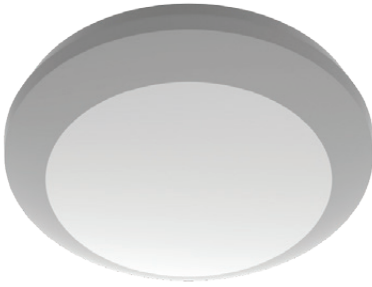

IP 66 3000K 4000K 6500K

Kod No	Özellikler	Koli Adedi	Fiyat
111226	15W 6500K	8	29,60 \$
111236	15W 6500K Sensör	8	43,60 \$
111245	15W 6500K Acil Ayd Kit	8	55,60 \$
111260	15W 6500K Sensör + Acil Ayd Kit	8	69,60 \$



Havana G2 - LED - Integrated Driver IP66

- BEYAZ
- GRİ
- SİYAH

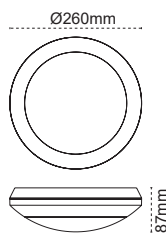
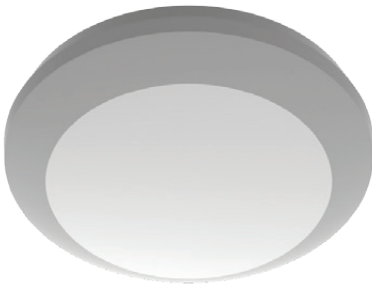

IP 66 3000K 4000K 6500K

Kod No	Özellikler	Koli Adedi	Fiyat
111692	18W 6500K	8	23,80 \$
111701	18W 6500K Sensör	8	37,80 \$



360° Hareket Sensörü

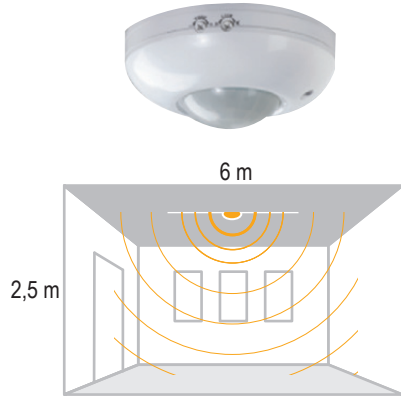

Kod No	Özellikler	Koli Adedi	Fiyat
314720	360 Derece Hareket Sensörü	50	9,00 \$

Varlık Sensörü

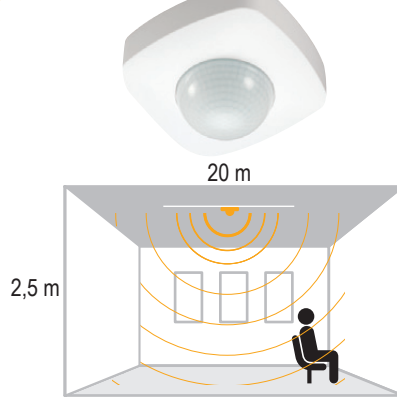

Kod No	Özellikler	Koli Adedi	Fiyat
314733	Varlık Sensörü	50	22,80 \$

Radar Sensör

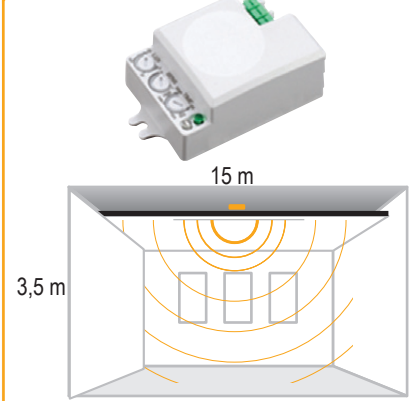

Kod No	Özellikler	Koli Adedi	Fiyat
314735	IP65 Sensör Kutusu	50	10,40 \$
314725	Radar Sensör	100	14,00 \$

180° Hareket Sensörü

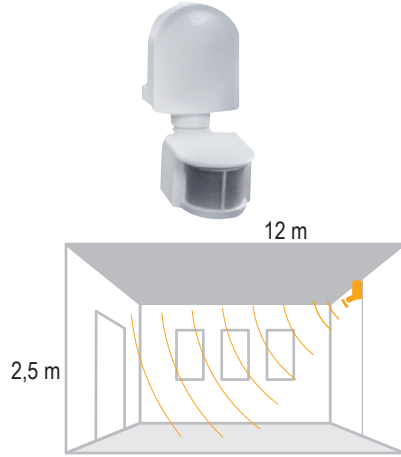

Kod No	Özellikler	Koli Adedi	Fiyat
314717	180 Derece Hareket Sensörü	50	8,40 \$

Sıva Altı Tavan Sensör

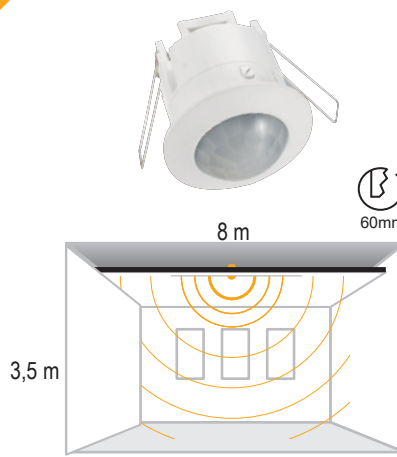

Kod No	Özellikler	Koli Adedi	Fiyat
314726	Sıva Altı Tavan Sensör	50	10,20 \$

Fotosel



Kod No	Özellikler	Koli Adedi	Fiyat
314738	Fotosel	100	5,40 \$

Yüksek Tavan Sensörü

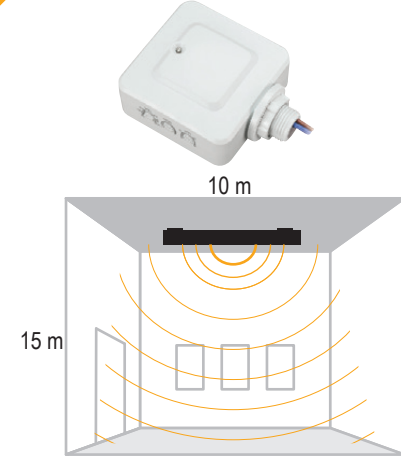

Kod No	Özellikler	Koli Adedi	Fiyat
314730	Yüksek Tavan Sensörü	50	32,40 \$

Dört Yönlü Hareket Sensörü

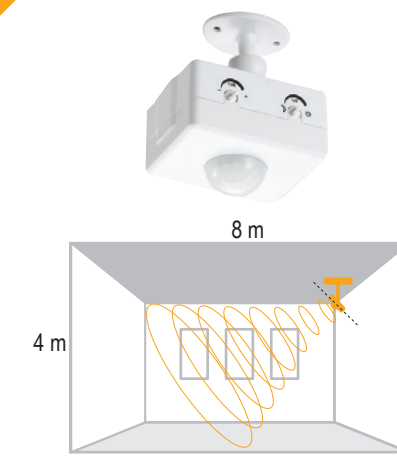

Kod No	Özellikler	Koli Adedi	Fiyat
314729	Dört Yönlü Hareket Sensörü	100	13,70 \$

Mini Hareket Sensörü

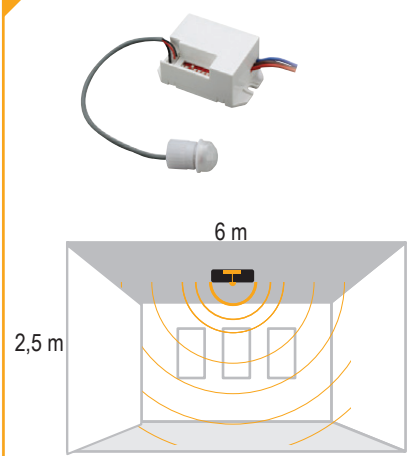

Kod No	Özellikler	Koli Adedi	Fiyat
314732	Mini Hareket Sensörü	100	8,40 \$

Acil Durumlarda Pelsan Güvencesi

Yeni

IP40 / IP65
Metal Spot Emergency



Oynar Başlık



Anahtarlı, Test Butonlu



Şarj, Deşarj Göstergeli



6 Saat Deşarj Süresi



Taşınabilir, Asılabilir



IP40 / IP65 Opsiyonel



Acil Aydınlatma / Yönlendirme Armatürleri



IP65 Exproof
Acil Aydınlatma Armatürü



Acil Yönlendirme
Armatürü



Acil Yönlendirme
Armatürü



IP65 Acil
Aydınlatma/Yönlendirme
Armatürü



-  Oynar Başlık
-  Anahtarlı, Test Butonlu
-  Şarj, Deşarj Göstergeli
-  6 Saat Deşarj Süresi
-  Taşınabilir, Asılabilir



IP65 Emergency Spot



Yeni Ürün

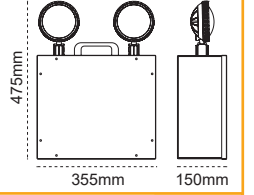

IP 65  4000K  6500K

Kod No	Özellikler	Koli Adedi	Fiyat
110679	2x10W 6 Saat 4000K	4	166,20 \$

Metal Kasa Emergency Spot



axbxcmm
2x5W :275x340x80
2x10W :325x340x80

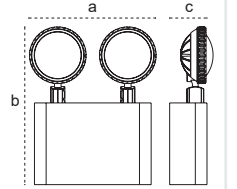

IP 40  4000K  6500K

Kod No	Özellikler	Koli Adedi	Fiyat
109781	2x5W 6 Saat 4000K	4	75,00 \$

IP 40  4000K  6500K

Kod No	Özellikler	Koli Adedi	Fiyat
109780	2x10W 6 Saat 4000K	4	130,00 \$

Emergency Spot

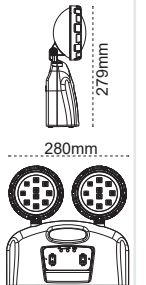
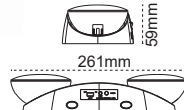

IP 40 

Kod No	Özellikler	Koli Adedi	Fiyat
203911	2x3W LEDli 6 Saat	10	43,00 \$

IP 40 

Kod No	Özellikler	Koli Adedi	Fiyat
203913	2x5W LEDli 4 Saat	8	66,50 \$

Pelsan Acil Aydınlatma ve Yönlendirme Armatürleri



5 W-10W, 3 Saat Deşarj Süresi

ENEC Belgeli Sürücü

IP65, Toz ve Su Almaz!

AC/DC Çalışma

Sıva Altı, Sıva Üstü Montaj



Dört Farklı Yönlendirme Etiketli Hediyeli



Ürün Tanıtım Videosu

Geniş Kullanım Alanı

Merdivenler Koridorlar Yangın Dolap Üstleri Tuvalet Girişleri Elektrik Pano Üstleri

IP65 Acil Aydınlatma ve Yönlendirme Armatürü Ausled (3 Saat)

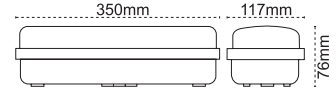

IP 65 4000K 6500K

Kod No	Özellikler	Koli Adedi	Fiyat
108390	5W 6500K Sıva Üstü	12	45,60 \$
315895	Sıva Altı Yayı (ikili)	1	1,00 \$

IP 65 4000K 6500K

Kod No	Özellikler	Koli Adedi	Fiyat
110667	10W 6500K Sıva Üstü	12	49,70 \$
315895	Sıva Altı Yayı (ikili)	1	2,70 \$

LED Ex-Proof Acil Ayd. Ausled IP65

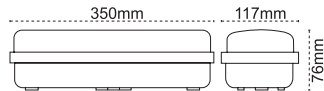

IP 65

Kod No	Özellikler	Koli Adedi	Fiyat
109710	15W 6500K	12	101,60 \$
323993	Ex-Proof Duvar Bağlantı Aparatı	-	1,00 \$

LED Ex-Proof Acil Ayd. Yönl. Rausled IP65



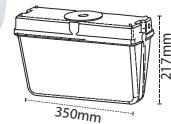

Yeni Ürün



IP 54 6500K

Kod No	Özellikler	Koli Adedi	Fiyat
111683	15W 6500K Sıva Üstü	12	101,60 \$



-  Alüminyum Gövde
-  3 Saat Deşarj Süresi
-  Şarj Göstergesi
-  AC/DC Çalışma
-  Sonsuz Etiket Opsiyonu

Acil Yönlendirme Armatürü Viald (3 Saat)

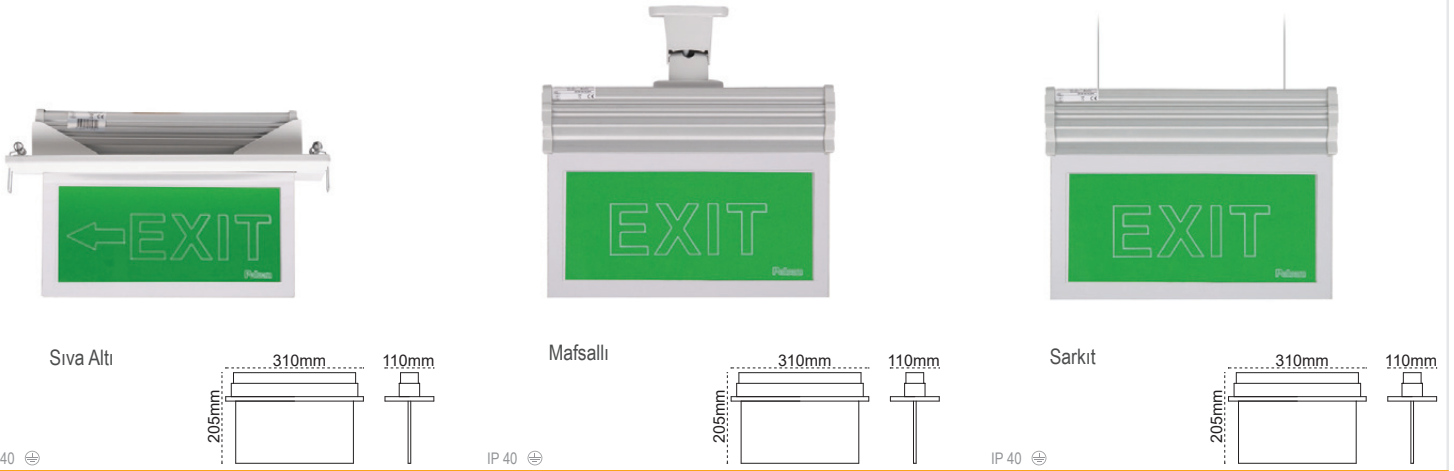

Kod No	Özellikler	Koli Adedi	Fiyat	Kod No	Özellikler	Koli Adedi	Fiyat	Kod No	Özellikler	Koli Adedi	Fiyat
201064	S.A. Tek Yön 3W	10	27,80 \$	200944	Mafsallı Tek Yön 3W	10	27,80 \$	201136	Sarkıt Tek Yön 3W	10	27,80 \$
201110	S.A. Çift Yön 3W	10	27,80 \$	201013	Mafsallı Çift Yön 3W	10	27,80 \$	201165	Sarkıt Çift Yön 3W	10	27,80 \$

IP65 Acil Yönlendirme Armatürü Rausled (3 Saat)

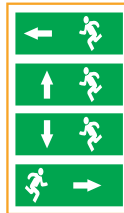

4 Farklı Yön Etiketli

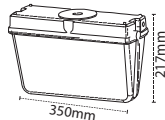

Kod No	Özellikler	Koli Adedi	Fiyat
109387	3W 6500K Sıva Üstü	10	56,00 \$

Acil Yönlendirme Armatürü 60cm Mega Viald (3 Saat)

Yeni Ürün

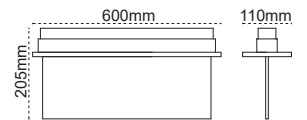

Kod No	Özellikler	Koli Adedi	Fiyat
201037	Mafsallı Tek Yön 60cm	10	46,50 \$
201041	Mafsallı Çift Yön 60cm	10	46,50 \$

Pelsan Acil Aydınlatma ve Yönlendirme Armatürleri

Çift Yön
Exiled (3 Saat)

sabit etiketli

IP 20

Kod No	Özellikler	Koli Adedi	Fiyat
203888	Çift Yön 3W	20	10,20 \$

Çift Yön
Exiled (3 Saat)

sabit etiketli

IP 20

Kod No	Özellikler	Koli Adedi	Fiyat
203889	Çift Yön 3W	20	10,20 \$

Çift Yön
Exiled (3 Saat)

sabit etiketli

IP 20

Kod No	Özellikler	Koli Adedi	Fiyat
203887	Çift Yön 3W	20	10,20 \$

Tek / Çift Yön
Exiled (3 Saat)

sabit etiketli

IP 20

Kod No	Özellikler	Koli Adedi	Fiyat
203891	Tek Yön 3W	20	10,20 \$
203885	Çift Yön 3W	20	10,20 \$

Çift Yön
Exiled (3 Saat)

sabit etiketli

IP 20

Kod No	Özellikler	Koli Adedi	Fiyat
203890	Çift Yön 3W	20	10,20 \$

Çift Yön
Exiled (3 Saat)

sabit etiketli

IP 20

Kod No	Özellikler	Koli Adedi	Fiyat
205688	Çift Yön 3W	20	10,20 \$

İşıldaklar

IP 40

Kod No	Özellikler	Koli Adedi	Fiyat
204619	30 LED'li İşıldak	40	8,80 \$
204620	40-60 LED'li İşıldak	24	15,20 \$
204623	90 LED'li İşıldak	20	24,80 \$

Solar İşıldak **Yeni Ürün**

Solar

220Vac

IP 20

Kod No	Özellikler	Koli Adedi	Fiyat
206489	60 LED'li İşıldak	20	14,80 \$

Acil Aydınlatma Kiti

IP 20

Kod No	Özellikler	Koli Adedi	Fiyat
313118	12-110V LED Konvertör Kit (1saat)	50	26,00 \$
316611	12-110V LED Konvertör Kit (3saat)	50	30,30 \$

220V Acil Aydınlatma Kiti

IP 20

Kod No	Özellikler	Koli Adedi	Fiyat
313117	3-20W LED Tube Konvertör Kit	25	26,00 \$

Fixline Lineer LED Armatür

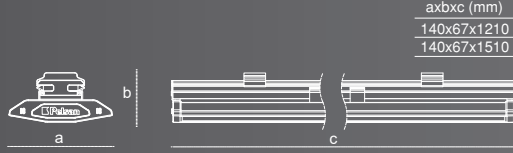

Kolay Lineer Bağlantı

 T5 Floresana göre %60'a varan tasarruf sağlar.

 Kolay lineer bağlantı

 ENEC belgeli sürücü

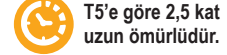
 T5'e göre 2,5 kat uzun ömürlüdür.

IP 20   

Kod No	Özellikler	Koli Adedi	Fiyat
113238	35W 6500K 120cm Opal Difüzör	6	77,80 \$
113239	35W 6500K 120cm Opal Difüzör Lineer Bağlantı	6	81,00 \$

Monoline Lineer LED Armatür



**120
lm/W
verimlilik**

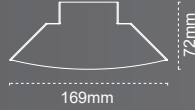

Kolay Lineer Bağlantı

 T5 Floresana göre %60'a varan tasarruf sağlar.

 Kolay lineer bağlantı

 ENEC belgeli sürücü

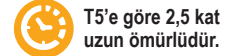
 T5'e göre 2,5 kat uzun ömürlüdür.

IP 20   

Kod No	Özellikler	Koli Adedi	Fiyat
109564	28W 6500K 111cm Opal Difüzör	6	48,90 \$
109566	35W 6500K 150cm Opal Difüzör	4	53,60 \$
105331	T8 Market Arm. 1x18W 120 cm LED Tube	5	30,20 \$
105332	T8 Market Arm. 1x24W 150 cm LED Tube	5	38,80 \$

Multiline Lineer LED Armatür

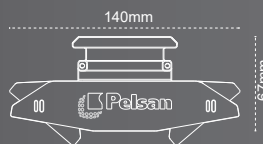
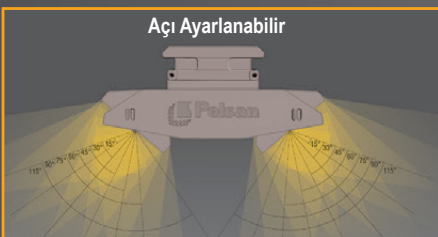

Işığa Hareket Kazandırır

- 7 kademeli ayarlanabilir ışık açısı ile ışığı istediğiniz noktaya yönlendirir.
- Sürekli lineer bağlantı
- Kamaşma önleyici özel difüzör
- 120 lm/W verimlilik
- ENEC belgeli sürücü

IP 40   

Kod No	Özellikler	Koli Adedi	Fiyat
105381	35W 6500K 120cm Opal Difüzör	4	123,50 \$
105383	35W 6500K 150cm Opal Difüzör	4	149,50 \$
105385	50W 6500K 150cm Opal Difüzör	4	159,50 \$
108508	35W 6500K 120cm Opal Difüzör Lineer Bağlantı	4	128,00 \$
108509	35W 6500K 150cm Opal Difüzör Lineer Bağlantı	4	152,00 \$
108416	50W 6500K 150cm Opal Difüzör Lineer Bağlantı	4	165,00 \$

Pelsan Bant Armatürler

Etanj Duyulu Sac Bant LED Tube Uygun - Impera



Tozlu ve Titreşimli Alanlar İçin!



- Tozlu Alanlar İçin Özel Duy Yapısı!
- Makine Titreşimlerinden Etkilenmez!
- LED Tube ile %50'yi Aşan Tasarruf!

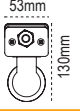

IP 54

Kod No	Özellikler	Koli Adedi	Fiyat
111276	Tekli 60cm	12	10,60 \$
111618	Tekli 120cm	12	12,20 \$
111620	Tekli 150cm	12	15,30 \$
111277	İkili 60cm	12	13,90 \$
111619	İkili 120cm	12	15,80 \$
111275	İkili 150cm	12	18,80 \$

Etanj Duyulu Polyester Bant LED Tube Uygun



Tozlu ve Nemli Alanlar İçin!



- IP65 Toz ve Su Almaz!
- Anti-Korozyon Gövde!
- LED Tube ile %50'yi Aşan Tasarruf!

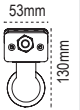

IP 65

Kod No	Özellikler	Koli Adedi	Fiyat
103200	Polyester Tekli 120cm	6	22,30 \$
103261	Polyester Tekli 150cm	6	24,20 \$
103210	Polyester İkili 120cm	6	25,30 \$
103268	Polyester İkili 150cm	6	27,20 \$

LED Tube TMS



Hem Tasarruflu Hem Ekonomik!



- En Ekonomik Bant Armatür!
- LED Tube ile %50'yi Aşan Tasarruf!
- Kolay ve Hızlı Kurulum!

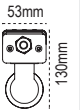

IP 20

Kod No	Özellikler	Koli Adedi	Fiyat
111279	TMS Tekli 60cm	12	4,60 \$
111621	TMS Tekli 120cm	12	7,10 \$
111280	TMS İkili 60cm	12	5,90 \$
111278	TMS İkili 120cm	12	9,10 \$

Linea Large G3 LED Bant Arm.



Ekonomik Bant Armatürü!



- Class II Ekstra Elektriksel Güvenlik
- Homojen Işık Çıktısı
- Kolay Kurulum

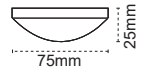

IP 20

Kod No	Özellikler	Koli Adedi	Fiyat
110149	36W 4000K 1155mm	20	10,40 \$
110150	36W 6500K 1155mm	20	10,40 \$

Türkiye'de TEK! GRP Gövde Etanj



Yüksek mekanik dayanım



UV ışınlarından etkilenmez



Anti korozyon, paslanmaz



Kimyasal dayanımı yüksek



850°C kızaran tel testinden geçer

LED Etanj Largo

5 Yıl
Garanti

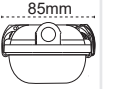

IP 65 ● 3000K ● 4000K ● 6500K

Kod No	Özellikler	Koli Adedi	Fiyat
109150	20W 6500K 60cm	6	24,00 \$
109151	36W 6500K 120cm	6	30,40 \$
109153	42W 6500K 150cm	6	42,50 \$

Yüksek Güçlü Etanj Largo LED MAX

75W
128lm/W



IP 65 ● 3000K ● 4000K ● 6500K

Kod No	Özellikler	Koli Adedi	Fiyat
113118	36W 6500K 60cm	6	28,50 \$
111114	50W 6500K 120cm	6	68,50 \$
111113	75W 6500K 120cm	6	73,30 \$

Pelsan Özel Etanj Armatürler

Largo Lens

Yeni Ürün

Lens Seçeneği



IP 65 3000K 4000K 6500K

Kod No	Özellikler
111195	75W 6500K 120cm 128 lm/W

Koli Adedi	Fiyat
6	119,00 \$

Otopark Fonksiyonlu LED Etanj Largo LED

**Maksimum
Tasarruf
Sağlar**



IP 65 3000K 4000K 6500K

Kod No	Özellikler
113489	36W 6500K 120cm Otopark Fonksiyonlu

Koli Adedi	Fiyat
6	72,00 \$

Soğuk Hava Deposu için LED Etanj Largo LED Frozen

-40°C'ye Kadar Çalışır.
Soğuk hava depoları ve donuk ürün depoları kullanımı için uygundur.



IP 65 3000K 4000K 6500K

Kod No	Özellikler
105871	21W 6500K 60cm (-25°C)
105884	42W 6500K 120cm (-40°C)
105894	63W 6500K 150cm (-40°C)

Koli Adedi	Fiyat
6	191,30 \$
6	213,80 \$
6	225,10 \$

Atex Belgeli Ex-Proof Etanj Largo Ex-Proof

Ex

- Gaz Patlama Koruması: Zone 2**
• II 3G Ex nR IIC T6 Gc
- Toz Patlama Koruması: Zone 22**
• II 3D Ex tc IIIC (T80 C) Dc



IP 65 3000K 4000K 6500K

Kod No	Özellikler	Koli Adedi	Fiyat
108458	25W LED 6500K Opal 60cm	6	180,00 \$
108459	45W LED 6500K Opal 120cm	6	196,70 \$
108297	2x18W T8 Şeffaf 60cm	6	115,00 \$
108298	2x36W T8 Şeffaf 120cm	6	119,80 \$

Prota G2



Yeni Ürün



5 YIL GARANTİ

IP65

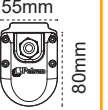

IP 65 3000K 4000K 6500K

Kod No	Özellikler	Koli Adedi	Fiyat
110178	19W 6500K 60cm	6	30,70 \$
110521	30W 6500K 90cm	6	39,00 \$
110520	34W 6500K 90cm	6	39,00 \$
110524	33W 6500K 120cm	6	48,20 \$
110179	40W 6500K 120cm	6	48,60 \$
110323	40W 6500K 150cm	4	56,10 \$
110526	45W 6500K 150cm	4	60,00 \$

Solida G2



IP65



5 YIL GARANTİ

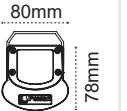

IP 65 3000K 4000K 6500K

Kod No	Özellikler	Koli Adedi	Fiyat
111052	19W 6500K 60cm	6	65,00 \$
111058	30W 6500K 90cm	6	67,00 \$
111059	34W 6500K 90cm	6	70,00 \$
111061	33W 6500K 120cm	6	89,00 \$
111062	40W 6500K 120cm	6	95,50 \$
111063	40W 6500K 150cm	4	106,50 \$
111064	44W 6500K 150cm	4	115,00 \$

Inovaled IP66



IP66

5 YIL GARANTİ

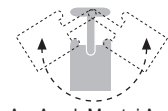

IP 66 3000K 4000K 6500K

Açı Ayarlı Montaj Aparatı

Kod No	Özellikler	Koli Adedi	Fiyat
113454	19W 6500K 60 cm	4	21,60 \$
113457	26W 6500K 90 cm	4	110,40 \$
113460	34W 6500K 120 cm	6	53,20 \$
326217	Açı ayarla montaj aparatı (2'li)		5,25 \$

Pelsan PC Etanj Armatürler

5 yıl
garanti



Kurum Şartnamelerine Uygun



Kolay
Montaj



Through
Wiring



Kolay
Elektriksel
Montaj



IP65
Su ve Toz
Almaz

Fontana IP66 50-100W



IP 65 ● 4000K ● 6500K

Kod No	Özellikler	Koli Adedi	Fiyat
111627	19W 6500K 60cm	6	34,20 \$
111628	26W 6500K 90cm	6	35,10 \$
111629	30W 6500K 90cm	6	36,00 \$
111630	34W 6500K 90cm	6	36,90 \$

IP 65 ● 4000K ● 6500K

Kod No	Özellikler	Koli Adedi	Fiyat
111631	33W 6500K 120cm	6	37,90 \$
111632	40W 6500K 120cm	6	44,30 \$
111633	40W 6500K 150cm	4	49,90 \$
111634	44W 6500K 150cm	4	53,60 \$

Fontana

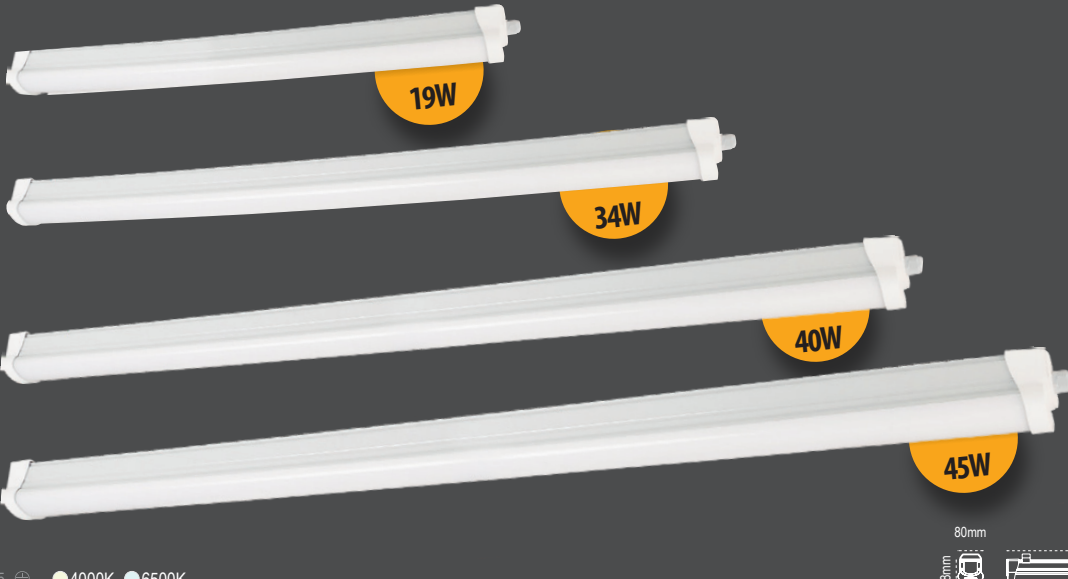

IP 65 ● 4000K ● 6500K

Kod No	Özellikler	Koli Adedi	Fiyat
111078	19W 6500K 60cm	6	26,80 \$
111079	26W 6500K 90cm	6	27,70 \$
111082	30W 6500K 90cm	6	28,60 \$
111083	34W 6500K 90cm	6	29,50 \$

Kod No	Özellikler	Koli Adedi	Fiyat
111084	33W 6500K 120cm	6	30,50 \$
111085	40W 6500K 120cm	6	36,90 \$
111086	40W 6500K 150cm	4	42,50 \$
111087	44W 6500K 150cm	4	46,20 \$



Largo LED Tube x1



x1
LED Tube

IP 65   4000K  6500K

Kod No	Özellikler	Koli Adedi	Fiyat
102669	LED Tube Tekli 60cm	6	13,50 \$
102713	LED Tube Tekli 120cm	6	17,20 \$
102867	LED Tube Tekli 150cm	6	33,80 \$



Largo LED Tube x2



x2
LED Tube

IP 65   4000K  6500K

Kod No	Özellikler	Koli Adedi	Fiyat
102687	LED Tube İkili 60cm	6	14,10 \$
102744	LED Tube İkili 120cm	6	19,80 \$
102878	LED Tube İkili 150cm	6	35,20 \$



Mar LED Tube x3



x3
LED Tube

IP 65   4000K  6500K

Kod No	Özellikler	Koli Adedi	Fiyat
108801	LED Tube Üçlü 60cm	6	25,90 \$
108800	LED Tube Üçlü 120cm	6	41,00 \$
102577	LED Tube Üçlü 150cm	6	53,90 \$

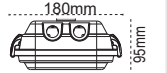

Mar LED Tube x4



x4
LED Tube

IP 65   4000K  6500K

Kod No	Özellikler	Koli Adedi	Fiyat
102574	LED Tube Dörtlü 120cm	6	43,10 \$
102579	LED Tube Dörtlü 150cm	6	58,30 \$

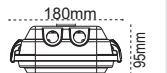

LED Tubeler

Kod No	Özellikler	Koli Adedi	Fiyat	Kod No	Özellikler	Koli Adedi	Fiyat
314664	9W 6500K	1	4,80 \$	319184	16W 6500K 140lm/W	1	11,30 \$
314665	18W 6500K	1	5,30 \$	323524	22W 6500K 135lm/W	1	18,50 \$
314668	22W 6500K	1	10,10 \$	313117	LED Tube Kiti	1	18,50 \$

Pelsan Benzinlik Armatürleri

Lenta

IP65 LED Kanopi Armatür

Yeni Ürün

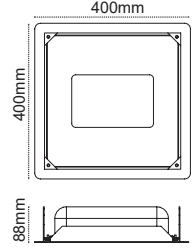

Sıva Üstü Farkı
19.00\$

Kod No	Özellikler	Koli Adedi	Fiyat
110507	100W 5000K	1	101,60 \$

Okta

IP65 LED Kanopi Armatür

80 W
140 lm/W



ENEC Belgesi Sürücü



+50.000 Saat Ömür



IP65, Toz ve Su Almaz!

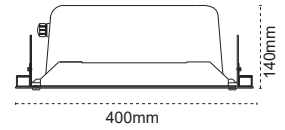

Lens Farkı
29.00\$

Kod No	Özellikler	Koli Adedi	Fiyat
106627	80W 6500K	1	129,30 \$
110173	100W 6500K	1	166,20 \$

Piroliz

IP65 LED Kanopi Armatür



ENEC Belgesi Sürücü



+50.000 Saat Ömür



IP65, Alüminyum Enjeksiyon Gövde

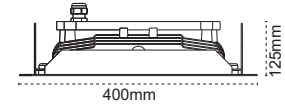

Kod No	Özellikler	Koli Adedi	Fiyat
109937	75W 6500K	1	333,00 \$
109938	100W 6500K	1	333,00 \$
109939	125W 6500K	1	333,00 \$

Piroliz Ex-Proof

IP66 LED Kanopi Armatür



- Gaz Patlama Koruması: II 3G Ex nR IIC T5 Gc
- Toz Patlama Koruması: II 3D Ex tc IIIC (T95 C) Dc

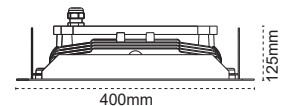

Kod No	Özellikler	Koli Adedi	Fiyat
111376	Piroliz Ex 50W 6500K	1	347,80 \$
111375	Piroliz Ex 75W 6500K	1	392,20 \$
111374	Piroliz Ex 100W 6500K	1	437,80 \$
111382	Piroliz Ex 125W 6500K	1	483,30 \$
111373	Piroliz Ex 150W 6500K	1	527,80 \$
111056	Piroliz Ex 200W 6500K	1	583,30 \$

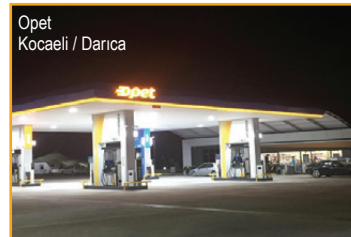

24V DC 100W
LED Projektör



24V DC

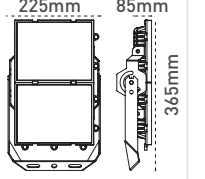

IP 66

Kod No	Özellikler
110506	100W 5700K

Koli Adedi	Fiyat
1	110,00 \$

24V DC 50W
LED Projektör



24V DC

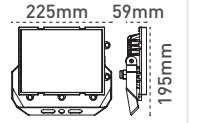

IP 66

Kod No	Özellikler
110171	50W 5700K

Koli Adedi	Fiyat
1	59,00 \$

24V DC 42W
LED Etanj / 120 cm



24V DC

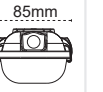

IP 65

Kod No	Özellikler
110114	42W 6500K 120cm

Koli Adedi	Fiyat
6	54,00 \$

24V DC 21W
LED Etanj / 60cm



24V DC



IP 65

Kod No	Özellikler
110119	21W 6500K 60cm

Koli Adedi	Fiyat
6	51,00 \$

Pelsan Yüksek Tavan Armatürleri

Cronto IP66

5
YIL
GARANTİ



En Zor Koşullarda 7/24 Çalışma!

Driver
Üstünlükleri



ENEC Belgesi
Sürücü



100.000 h
Driver Ömrü



10kV Dahili
Parafudr



-40°C +55°C



IP67



100-305Vac @48h
Gerilim Dalgalanmalarından Etkilenmez

Cronto IP66 150W-200W

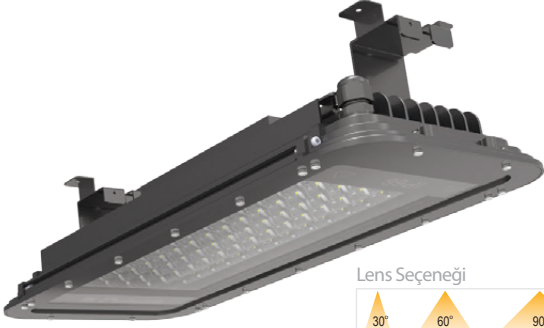

Lens Seçeneği



IP 66 4000K 6500K

Kod No	Özellikler	Koli Adedi	Fiyat
111333	150W 5700K 90°	1	262,50 \$
111334	200W 5700K 90°	1	277,00 \$

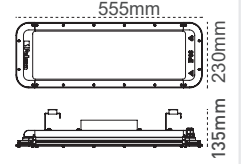

Cronto IP66 250W-300W



Lens Seçeneği



IP 66 4000K 6500K

Kod No	Özellikler	Koli Adedi	Fiyat
111331	250W 5700K 90°	1	346,50 \$
111332	300W 5700K 90°	1	346,50 \$

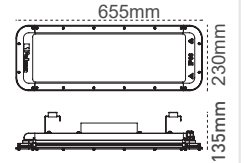

Cronto IP66 350W-400W



Lens Seçeneği



IP 66 4000K 6500K

Kod No	Özellikler	Koli Adedi	Fiyat
111335	350W 5700K 90°	1	462,50 \$
111336	400W 5700K 90°	1	462,50 \$

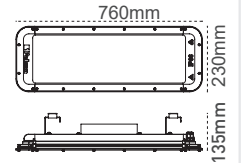

Etna G2



7/24 Çalışan

Endüstriyel Tesislerde

Ultra Performans!

5 5 Yıl Garanti

ENEC Belgeli Sürücü

72.000 Saat LED Çip Ömrü

150 lm/W'a Varan Verimlilik Faktörü

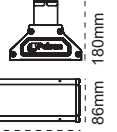

IP 65 4000K 6500K

IP 65 4000K 6500K

Kod No	Özellikler	Dar Açı	a (mm)	Koli Adedi	Fiyat
111273	100W 6500K	Dar Açı	60cm	1	134,80 \$
111271	150W 6500K	Dar Açı	90cm	1	188,40 \$
111269	200W 6500K	Dar Açı	120cm	1	279,10 \$
111258	250W 6500K	Dar Açı	150cm	1	328,30 \$
111256	300W 6500K	Dar Açı	150cm	1	328,30 \$

Kod No	Özellikler	Geniş Açı	a (mm)	Koli Adedi	Fiyat
111272	100W 6500K	Geniş Açı	60cm	1	134,80 \$
111270	150W 6500K	Geniş Açı	90cm	1	188,40 \$
111259	200W 6500K	Geniş Açı	120cm	1	279,10 \$
111257	250W 6500K	Geniş Açı	150cm	1	328,30 \$
111255	300W 6500K	Geniş Açı	150cm	1	328,30 \$

Etna G2 Heavy Industry



Ağır Sanayi

Tesisleri için

Ultra Performans!

+70° C'ye Kadar Çalışır.



IP 65 4000K 6500K

Kod No	Özellikler	a (mm)	Koli Adedi	Fiyat
113466	100W 6500K Dar Açı	1200	1	287,50 \$
113467	200W 6500K Dar Açı	1500	1	374,50 \$

Duvar Bağlantı Aparatı



Etna G2 Food



Gıda

Tesisleri için

Ultra Performans!

IP 65 4000K 6500K

Kod No	Özellikler	a (mm)	Koli Adedi	Fiyat
113336	100W 6500K Dar Açı	600	1	179,80 \$
113338	150W 6500K Dar Açı	900	1	233,40 \$
113340	200W 6500K Dar Açı	1200	1	324,10 \$
113342	250W 6500K Dar Açı	1500	1	373,30 \$
113344	300W 6500K Dar Açı	1500	1	373,30 \$

Etna G2 Frozen

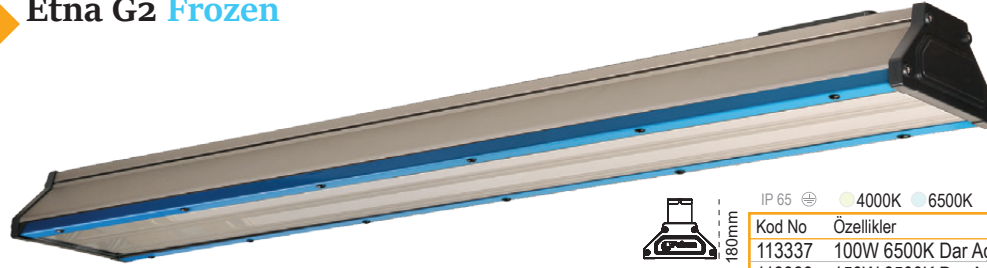

Soğuk Hava

Depoları için

Ultra Performans!

-40° C'ye Kadar Çalışır.



IP 65 4000K 6500K

Kod No	Özellikler	a (mm)	Koli Adedi	Fiyat
113337	100W 6500K Dar Açı	600	1	229,80 \$
113339	150W 6500K Dar Açı	900	1	283,40 \$
113341	200W 6500K Dar Açı	1200	1	374,10 \$
113343	250W 6500K Dar Açı	1500	1	423,30 \$
113345	300W 6500K Dar Açı	1500	1	423,30 \$

Kod No	Özellikler	Koli Adedi	Fiyat
316387	Etna G2 Busbar Askı Takımı	1	6,30 \$

Pelsan Yüksek Tavan Armatürleri

Hima G2

IP65 Alüminyum Yüksek Tavan Armatürü



75W
120lm/W

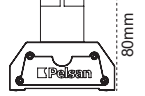

+50.000 Saa
Armatür Ömrü



ENEC
Belgeli Sürücü



IP65
Su Almaz!

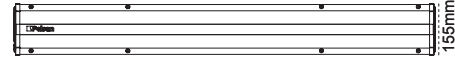

IP 65 4000K 6500K

Kod No	Özellikler	a (cm)	Koli Adedi	Fiyat	Kod No	Özellikler	a (cm)	Koli Adedi	Fiyat
111072	75W 6500K	90cm	1	103,40 \$	111073	100W 6500K	90cm	1	110,80 \$
					111066	150W 6500K	120cm	1	134,80 \$

Karpat G2

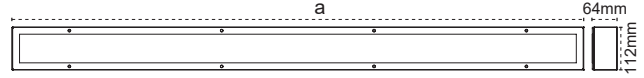

IP 65

IP 65 6500K

Kod No	Özellikler	a (cm)	Koli Adedi	Fiyat	Kod No	Özellikler	a (cm)	Koli Adedi	Fiyat
111104	2X54W T5	120 cm	1	61,90 \$	111105	75W 6500K	120 cm	1	70,20 \$
111663	2X80W T5	150 cm	1	86,80 \$	111766	120W 6500K	120 cm	1	107,10 \$
					113479	150W 6500K	150 cm	1	127,40 \$

Süphan T5

IP65 Yüksek Tavan Armatürü

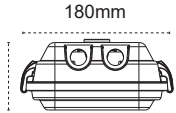

Temperli Cam



GRP Gövde



2x54W / 2x80W

IP 65

IP 65 6500K

Kod No	Özellikler	a (cm)	Koli Adedi	Fiyat	Kod No	Özellikler	a (cm)	Koli Adedi	Fiyat
109222	2x54W T5	120 cm	1	46,20 \$	108993	75W 6500K	120 cm	1	64,60 \$
109223	2x80W T5	150 cm	1	72,00 \$	113116	120W 6500K	120 cm	1	99,70 \$

Salto

IP65 Alüminyum Yüksek Tavan Armatürü



IP 65

Kod No	Özellikler	a (mm)	Koli Adedi	Fiyat
111001	60W 5000K	500	1	71,90 \$
110170	100W 5000K	600	1	80,00 \$
110592	150W 5000K	900	1	122,60 \$
110593	200W 5000K	755	1	165,30 \$
110981	300W 5000K	785	1	242,90 \$

Kod No	Özellikler	Koli Adedi	Fiyat
316387	Etna G2 / Hima G2 / Karpat G2 Busbar Askı Takımı	1	6,30 \$
318032	Süphan / Largo Busbar Askı Takımı	1	6,30 \$

Yüksek Tavan Armatürleri **Pelsan**

75-100W
Ø295

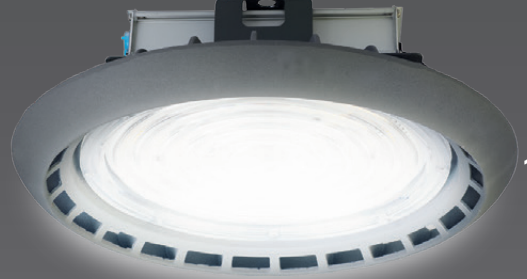
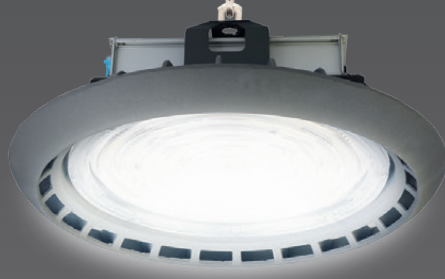

150-200W
Ø345



130lm/W



Acil Kit



Reflektör
Opsiyonu



45°/90°
Lens Seçeneği

**Driver
Üstünlükleri**



ENEC Belgeli
Sürücü



100.000 h
Driver Ömrü



10kV Dahili
Parafudr



-40°C +55°C



IP67



100-305Vac @48h
Gerilim Dalgalanmalarından Etkilenmez

Castor G2 75W-100W
IP65 Alm. Enj. Yüksek Tavan Armatürü

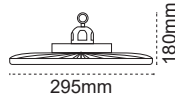

IP 65

Kod No	Özellikler	Koli Adedi	Fiyat
112983	75W 5700K	6	116,50 \$
112984	100W 5700K	6	126,50 \$

Castor G2 150W-200W
IP65 Alm. Enj. Yüksek Tavan Armatürü

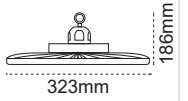

IP 65

Kod No	Özellikler	Koli Adedi	Fiyat
112985	150W 5700K	4	170,30 \$
112986	200W 5700K	4	210,30 \$

Monte G2 100W
IP65 Alm. Enj. Yüksek Tavan Armatürü

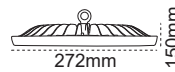
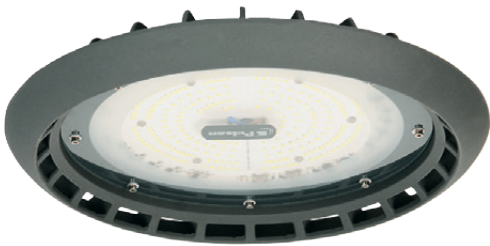

IP 65

Kod No	Özellikler	Koli Adedi	Fiyat
110569	100W 5700K	6	97,40 \$

Monte G2 150W
IP65 Alm. Enj. Yüksek Tavan Armatürü

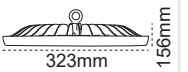

IP 65

Kod No	Özellikler	Koli Adedi	Fiyat
110570	150W 5700K	1	137,00 \$

Kod No	Özellikler	Koli Adedi	Fiyat
325718	Castor G2 Busbar Askı Takımı	1	3,70 \$
325458	Castor G2 Kamaşma Önleyici Reflektör	1	19,20 \$

Pelsan Yüksek Tavan Armatürleri

Sia



Sia Yüksek Tavan



Sia Ex-Proof



Sia Heavy Industry

Farklı Lens Açı Opsiyonları



Driver Üstünlükleri



ENEC Belgeli Sürücü



100.000 h Driver Ömrü



10kV Dahili Parafudr



-40°C +55°C



IP67



100-305Vac @48h Gerilim Dalgalanmalarından Etkilenmez

Sia Yüksek Tavan Armatürü

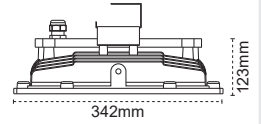

IP 65 4000K 6500K

Kod No	Özellikler	Koli Adedi	Fiyat
109221	150W 6500K	1	344,00 \$
109554	200W 6500K	1	363,00 \$

Sia Heavy Industry Yüksek Tavan Armatürü



Ağır Sanayi Tesisleri İçin Kesin Çözüm!

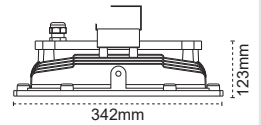

IP 65 4000K 6500K

Kod No	Özellikler	Koli Adedi	Fiyat
110603	100W 6500K	1	343,00 \$
110604	125W 6500K	1	350,00 \$
110605	150W 6500K	1	357,00 \$

+70° C'ye Kadar Çalışır.

Ex-Proof Yüksek Tavan Arm.

Sia



- Toz Patlama Koruması: Zone 22
- Gaz Patlama Koruması: Zone 2

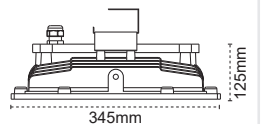

IP 66 4000K 6500K

Kod No	Özellikler	Koli Adedi	Fiyat
111381	Sia Ex 50W 6500K	1	347,80 \$
111380	Sia Ex 75W 6500K	1	392,20 \$
111379	Sia Ex 100W 6500K	1	437,80 \$
111378	Sia Ex 125W 6500K	1	483,30 \$
111377	Sia Ex 150W 6500K	1	527,80 \$
111053	Sia Ex 200W 6500K	1	583,30 \$

Kapalı Spor Salonu Armatürleri **Pelsan**



Ürün Broşürü



Profesyonel Spor Salonları İçin
Kusursuz Aydınlatma Deneyimi

- IK10, Yüksek Darbe Dayanımı
- Kamaşma Önleyici Optik Tasarım
- HD Çekim Kalitesine Uygun
- 150 lm/W Etkinlik Faktörü
- Lens Opsiyonları

Lens Seçeneği

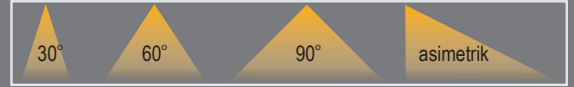

Neta 60°

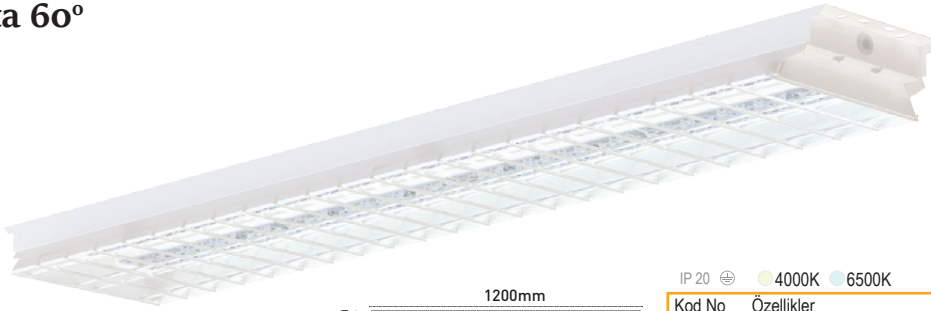

IP 20 4000K 6500K

Kod No	Özellikler	Koli Adedi	Fiyat
110687	100W 6500K 130cm 60°	1	328,00 \$
110688	150W 6500K 130cm 60°	1	369,00 \$
110689	200W 6500K 130cm 60°	1	410,00 \$



Neta 90°

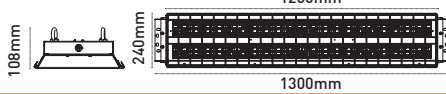

IP 20 4000K 6500K

Kod No	Özellikler	Koli Adedi	Fiyat
110684	100W 6500K 130cm 90°	1	328,00 \$
110685	150W 6500K 130cm 90°	1	369,00 \$
110686	200W 6500K 130cm 90°	1	410,00 \$



Neta Asimetrik

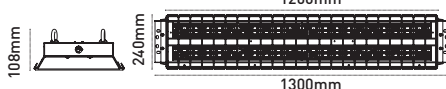

IP 20 4000K 6500K

Kod No	Özellikler	Koli Adedi	Fiyat
110787	100W 6500K 130cm Asimetrik	1	328,00 \$
110788	150W 6500K 130cm Asimetrik	1	369,00 \$
110789	200W 6500K 130cm Asimetrik	1	410,00 \$





ATEX Belgeli Ex-Proof Armatürler

Pelsan

Toz Patlama Koruması: Zone 22
Gaz Patlama Koruması: Zone 2

LED Ex-Proof Acil Ayd. Ausled IP65

Yeni Ürün

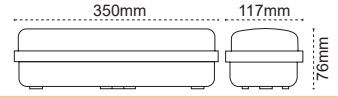

IP 65

Kod No	Özellikler
109710	15W 6500K

Koli Adedi	Fiyat
12	101,60 \$



LED Tube Ex-Proof Etanj Largo IP65 60cm/120cm

Yeni Ürün

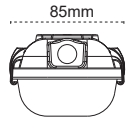

IP 65

Kod No	Özellikler	Koli Adedi	Fiyat
111402	1x9W LED Tube Tekli Şeffaf 60cm	6	75,60 \$
111404	2x9W LED Tube İkili Şeffaf 120cm	6	77,80 \$
111405	1x18W LED Tube Tekli Şeffaf 60cm	6	90,00 \$
111406	2x18W LED Tube İkili Şeffaf 120cm	6	92,25 \$

LED Ex-Proof Etanj Largo IP65 60cm/120cm

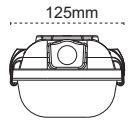

IP 65

Kod No	Özellikler	Koli Adedi	Fiyat
108458	25W LED 6500K Opal 60cm	6	180,00 \$
108459	45W LED 6500K Opal 120cm	6	196,70 \$

T8 Ex-Proof Etanj Largo IP65 60cm/120cm

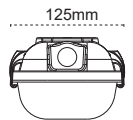

IP 65

Kod No	Özellikler	Koli Adedi	Fiyat
108297	2x18W Şeffaf 60cm	6	115,00 \$
108298	2x36W Şeffaf 120cm	6	119,80 \$



ATEX Belgeli Ex-Proof Armatürler:

Pelsan

Toz Patlama Koruması: Zone 22
Gaz Patlama Koruması: Zone 2

50W Ex-Proof Proejktör Elit Lirad

Yeni Ürün

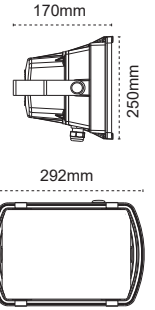

IP 65 4000K 6500K

Kod No Özellikler
109707 Elit Lirad Ex 50W 6500K

Koli Adedi Fiyat
6 221,60 \$

Ex-Proof Yüksek Tavan Arm. Sia

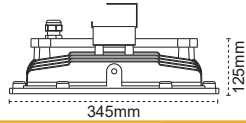

IP 66 4000K 6500K

Kod No	Özellikler	Koli Adedi	Fiyat
111381	Sia Ex 50W 6500K	1	347,80 \$
111380	Sia Ex 75W 6500K	1	392,20 \$
111379	Sia Ex 100W 6500K	1	437,80 \$
111378	Sia Ex 125W 6500K	1	483,30 \$
111377	Sia Ex 150W 6500K	1	527,80 \$
111053	Sia Ex 200W 6500K	1	583,30 \$

Ex-Proof Projektör Nairo

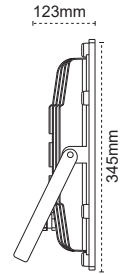

IP 66 4000K 6500K

Kod No	Özellikler	Koli Adedi	Fiyat
111372	Nairo Ex 50W 6500K	1	347,80 \$
111371	Nairo Ex 75W 6500K	1	392,20 \$
111370	Nairo Ex 100W 6500K	1	437,80 \$
111369	Nairo Ex 125W 6500K	1	483,30 \$
111368	Nairo Ex 150W 6500K	1	527,80 \$
111055	Nairo Ex 200W 6500K	1	583,30 \$

Ex-Proof Kanopi Armatürü Piroliz

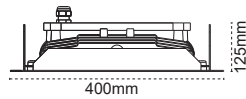

IP 66 4000K 6500K

Kod No	Özellikler	Koli Adedi	Fiyat
111376	Piroliz Ex 50W 6500K	1	347,80 \$
111375	Piroliz Ex 75W 6500K	1	392,20 \$
111374	Piroliz Ex 100W 6500K	1	437,80 \$
111382	Piroliz Ex 125W 6500K	1	483,30 \$
111373	Piroliz Ex 150W 6500K	1	527,80 \$
111056	Piroliz Ex 200W 6500K	1	583,30 \$

Ex-Proof Yol-Cadde Armatürü Nairo

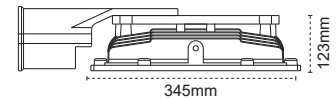

IP 66 4000K 6500K

Kod No	Özellikler	Koli Adedi	Fiyat
111365	Nairo Ex 100W 4000K	1	521,00 \$
111364	Nairo Ex 125W 4000K	1	575,00 \$
111363	Nairo Ex 150W 4000K	1	630,00 \$
111362	Nairo Ex 200W 4000K	1	670,00 \$

Pelsan Wallwasher

Uzun Ömürlü, Yüksek Verimli...

Gaziantep Kalesi LED Aydınlatması,
Pelsan Aydınlatma M. Reşit Göğüş tarafından yapılmıştır.



IP66 Toz ve Su Almaz



Temperli Cam



IK08 Darbe Dayanımı



Alüminyum Gövde



Hava Ventilli Rakor ile Nem Yapmaz!

S.Ü. Wallwasher IP66 Inoaled G2



Renk Farkı
YOK!

● AMBER ● YEŞİL ● MAVİ ● KIRMIZI



15W

35 cm



30W

65 cm



45W

95 cm

Renk Opsiyonları



Lens Açısı

45+20°

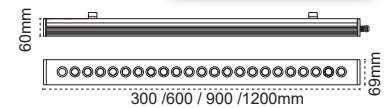
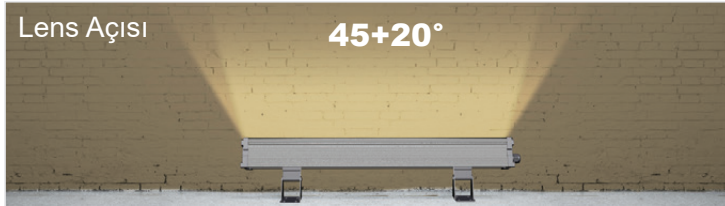

Kod No	Özellikler	Koli Adedi	Fiyat	Kod No	Özellikler	Koli Adedi	Fiyat
113291	14W 45+20 Derece 4000K 350mm	1	39,60 \$	113327	42W 45+20 Derece 4000K 945mm	1	99,50 \$
113319	28W 45+20 Derece 4000K 650mm	1	63,70 \$				

Cruzo IP66



ürün videosu

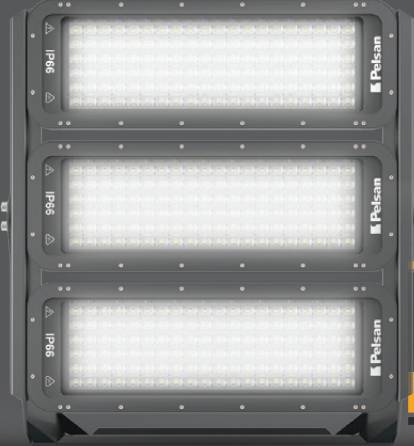

1000W

LED Projektör

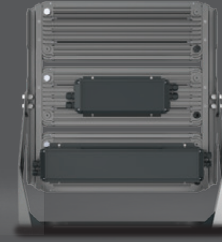

Lens Opsiyonları

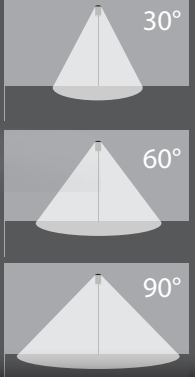

Driver Üstünlükleri



ENEC Belgeli Sürücü



100.000 h Driver Ömrü



10kV Dahili Parafudr



-40°C +55°C



IP67



100-305Vac @48h Gerilim Dalgalarının Etkilenmez

Cruzo IP66 300-500W LED Projektör

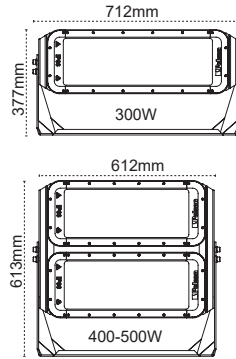

IP 66

Kod No	Özellikler	axbxc mm	Koli Adedi	Fiyat
110791	300W 5700K	712x377x226	1	474,40 \$
110792	400W 5700K	612x613x294	1	776,70 \$
110793	500W 5700K	612x613x294	1	776,70 \$

Cruzo IP66 600W LED Projektör

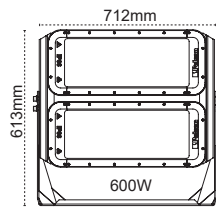

IP 66

Kod No	Özellikler	axbxc mm	Koli Adedi	Fiyat
110794	600W 5700K	712x613x294	1	911,10 \$

Cruzo IP66 800-1000W LED Projektör

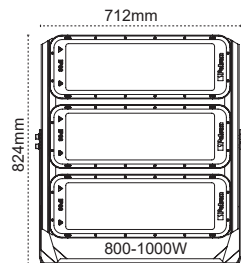

IP 66

Kod No	Özellikler	axbxc mm	Koli Adedi	Fiyat
110795	800W 5700K	712x824x345	1	1.437,80 \$
110796	900W 5700K	712x824x345	1	1.437,80 \$
110797	1000W 5700K	712x824x345	1	1.437,80 \$

Reflektörlü Özgün Tasarım



Simetrik
100-150W



Asimetrik
180-240W



Simetrik
180-300W

**Driver
Üstünlükleri**



ENEC Belgeli
Sürücü



100.000 h
Driver Ömrü



10kV Dahili
Parafudr



-40°C +55°C



IP67



100-305Vac @48h
Gerilim Dalgalanmalarından Etkilenmez

Ria IP66 Simetrik 180-300w

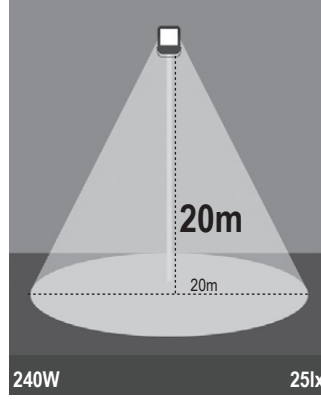

EN YÜKSEK Direkler İçin...

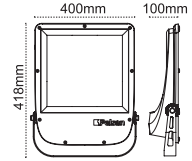

IP 66 4000K 6500K

Kod No	Özellikler	Koli Adedi	Fiyat
107140	180W Simetrik 6500K	1	268,40 \$
107141	200W Simetrik 6500K	1	276,80 \$
107130	250W Simetrik 6500K	1	294,70 \$
109218	300W Simetrik 6500K	1	321,10 \$

Ria IP66 Asimetrik 180-240w



İŞIĞI UZAĞA ATAN Asimetrik Tasarım

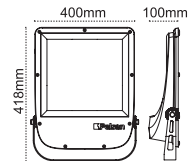

IP 66 4000K 6500K

Kod No	Özellikler	Koli Adedi	Fiyat
107137	180W Asimetrik 6500K	1	262,90 \$
107138	200W Asimetrik 6500K	1	271,10 \$
107127	240W Asimetrik 6500K	1	288,70 \$

Ria IP66 100-150w

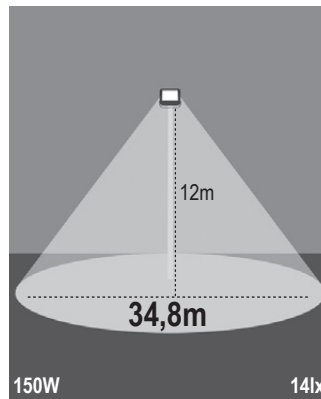

GENİŞ Alanlar için...

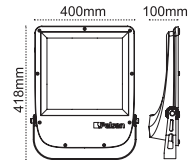

IP 66 4000K 6500K

Kod No	Özellikler	Koli Adedi	Fiyat
109209	100W Simetrik 6500K	1	221,60 \$
109210	125W Simetrik 6500K	1	230,80 \$
109211	150W Simetrik 6500K	1	230,80 \$



200-300W

Ria Lens



Yeni Ürün
60-150W

Ria Med G2



**Driver
Üstünlükleri**



**ENEC Belgeli
Sürücü**



**100.000 h
Driver Ömrü**



**10kV Dahili
Parafudr**



-40°C +55°C



IP67



100-305Vac @48h
Gerilim Dalgalanmalarından Etkilenmez

Ria Med G2

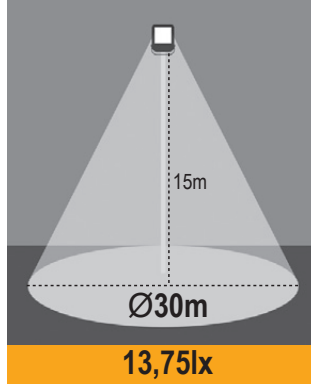

W 60 - 150W

7,560 - 17,700 lm

IK09 Darbe Dayanımı

Yeni Ürün

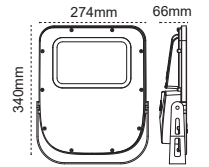

IP 66 4000K 6500K

Kod No	Özellikler	Koli Adedi	Fiyat
111788	60W 6500K	4	101,60 \$
111785	80W 6500K	4	129,30 \$
111660	100W 6500K	4	129,30 \$
111666	150W 6500K	4	150,50 \$

**Ria IP66 Simetrik
180-300w**



Farklı Lens Açı Opsiyonları

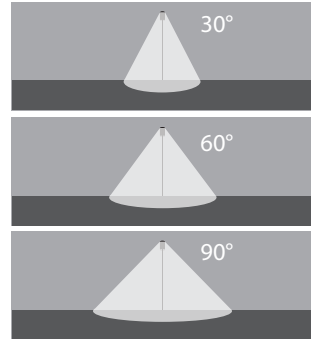

FARKLI LENS AÇILARI

30°-60°-90°

Yeni Ürün

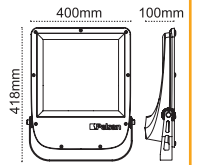

IP 66 4000K 6500K

Kod No	Özellikler	Koli Adedi	Fiyat
110356	200W Simetrik 6500K 90° Lens	1	337,00 \$
110355	250W Simetrik 6500K 90° Lens	1	359,00 \$
110354	300W Simetrik 6500K 90° Lens	1	396,00 \$

**Ria IP66 Asimetrik
180-240w**



**İŞIĞI UZAĞA ATAN
Asimetrik Tasarım**

Yeni Ürün

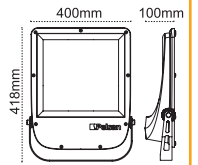

IP 66 4000K 6500K

Kod No	Özellikler	Koli Adedi	Fiyat
110770	200W Asimetrik 6500K	1	337,00 \$
110771	250W Asimetrik 6500K	1	359,00 \$
110772	300W Asimetrik 6500K	1	396,00 \$

Pelsan LED Projektörler

Sterio IP66



W 50 / 450W Güç Opsiyonu

+100 lm/W

IP66 Su ve Toz Almaz

IK10 Gövde

Sterio IP66 450W LED Projektör

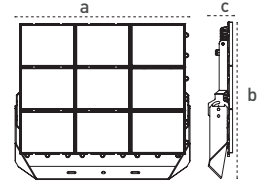

IP 66

Kod No	Özellikler	axbxc	Koli Adedi	Fiyat
109538	450W 5700K	795x390x85	1	460,00 \$

Sterio IP66 300W LED Projektör

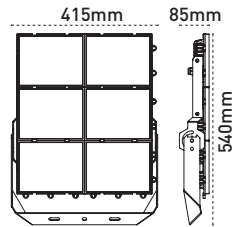

IP 66

Kod No	Özellikler	Koli Adedi	Fiyat
109537	300W 5700K	1	347,00 \$

Sterio IP66 200W LED Projektör

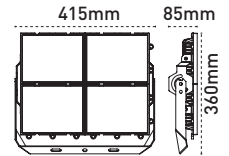

IP 66

Kod No	Özellikler	Koli Adedi	Fiyat
109536	200W 5700K	1	223,00 \$

Sterio IP66 100W LED Projektör

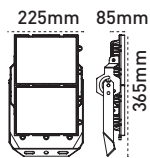

IP 66

Kod No	Özellikler	Koli Adedi	Fiyat
109666	100W 5700K	1	95,80 \$

Sterio IP66 50W LED Projektör

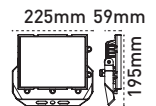

IP 66

Kod No	Özellikler	Koli Adedi	Fiyat
109787	50W 5700K	1	47,90 \$

Tartışmasız **EN İYİSİ** Lecto



200W

Lecto sıradan projektörlere göre;

- **%45 daha ağır gövdeye sahiptir.** Etkin soğutma sağlar. Uzun ömürlüdür.
- **%33 daha fazla ışık çıktısı sunar.** 100lm/W etkinlik faktörüne sahiptir.
- Güçlü elektriksel tasarımı ile **arıza yapmaz.**
 - Giriş gerilim filtresi
 - Akım sınırlayıcı
 - Giriş gerilim toleransı geniştir.



1 Hava Ventili ile Nem Yapmaz



2 360° Döner Konsol



3 Metal Rakor



4 Alüminyum Enjeksiyon Gövde

200W LED Projektör
Lecto

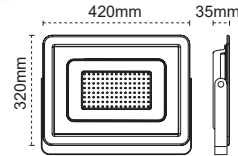

IP 65

Kod No	Özellikler	Koli Adedi	Fiyat
111284	200W 5000K	2	133,00 \$

150W LED Projektör
Lecto

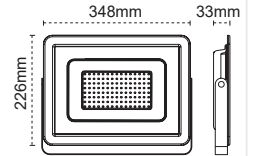

IP 65

Kod No	Özellikler	Koli Adedi	Fiyat
109306	150W 5000K	2	94,50 \$

100W LED Projektör
Lecto

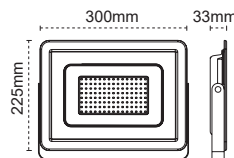

IP 65

Kod No	Özellikler	Koli Adedi	Fiyat
109305	100W 5000K	4	53,60 \$

50W LED Projektör
Lecto

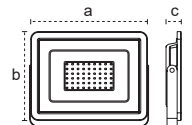

IP 65

Kod No	Özellikler	axbxcmm	Koli Adedi	Fiyat
109304	50W 5000K	230x175x30	6	25,50 \$

Pelsan LED Projektörler

Franko 400W



IP 65

670mm 180mm
320mm

Kod No	Özellikler	Koli Adedi	Fiyat
107117	400W 5000K	1	391,00 \$

Franko 200W



IP 65

520mm 160mm
320mm

Kod No	Özellikler	Koli Adedi	Fiyat
107112	200W 5000K	1	189,50 \$

Franko 150W



IP 65

420mm 166mm
320mm

Kod No	Özellikler	Koli Adedi	Fiyat
107109	150W 5000K	2	141,80 \$

Franko 100W



IP 65

288mm 86mm
335mm

Kod No	Özellikler	Koli Adedi	Fiyat
107105	100W 4000K	4	77,30 \$
107106	100W 6500K	4	77,30 \$

Franko 50W



IP 65

230mm 65mm
285mm

Kod No	Özellikler	Koli Adedi	Fiyat
107102	50W 6500K	6	42,50 \$

Franko 30W



IP 65

85mm 50mm
223mm

Kod No	Özellikler	Koli Adedi	Fiyat
107100	30W 6500K	10	29,50 \$

Franko 50W Amber - Yeşil



IP 65

230mm 65mm
285mm

Kod No	Özellikler	Koli Adedi	Fiyat
108166	50W Amber	6	58,50 \$
108167	50W Yeşil	6	58,50 \$

Acil Kitli / Radar Sensörlü LED Projektör



1 saat
Acil Durum Aydınlatma

axbxcmm
50W: 285x230x65
100W: 335x288x86

IP 65

Kod No	Özellikler	Koli Adedi	Fiyat
109732	100W 6500K Acil Kiti	4	114,90 \$
108932	50W 6500K Radar Sensörlü	6	60,00 \$

Accra Solar



Doğadan Gelen Güç!

Accra Solar enerji hatlarının bulunmadığı alanlar için en ekonomik aydınlatma çözümüdür!



- 1 Kablolama masrafı yok!
- 2 Elektrik masrafı yok!
- 3 Komple sistem çözümüdür! (Batarya ve solar panel dahil)
- 4 Uzaktan kumanda ile kontrol edilebilir.
- 5 Gün içinde depoladığı enerji ile 2 gün aydınlatma sağlar.

Sensör Algılama Mesafesi

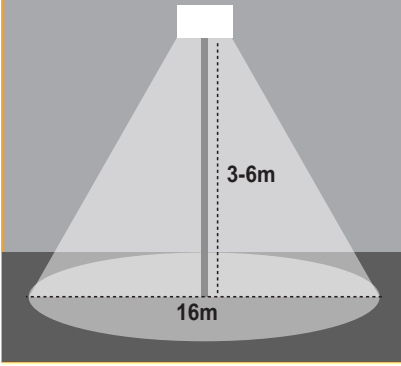

Kumanda ile Kontrol

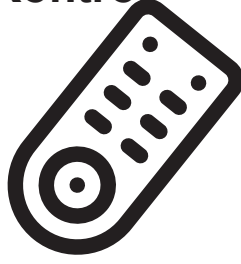

- 1 Mod 1: Radar sensörü aktif eder.
- 2 Mod 2: Radar sensör aktif değil. %50 yanar.
- 3 Mod 3: Kapalı
- 4 Mod 4: Zaman ayarı / Sürekli yanan mod



Etkinlik Alanları



Dağ Evleri



Kırsal Alanlar

40W Solar Aydınlatma Armatürü Accra

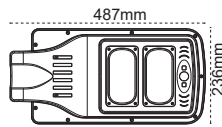

IP 65

Kod No	Özellikler	Koli Adedi	Fiyat
109431	40W 6500K	10	69,50 \$

60W Solar Aydınlatma Armatürü Accra

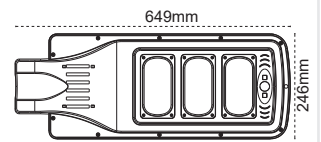

IP 65

Kod No	Özellikler	Koli Adedi	Fiyat
109432	60W 6500K	10	94,30 \$

Pelsan IP66 LED Yol Aydınlatma Armatürleri

Rio XS IP66

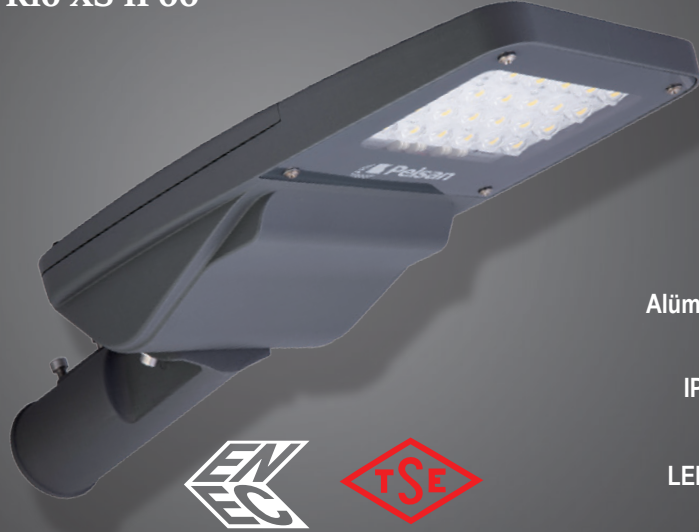

30-50-60-80-100W **W**

IP66, Toz ve Su Almaz! 

Alüminyum Enjeksiyon Gövde 

IP67, ENEC Belgeli Sürücü 

LED Çip Ömrü, +100.000 hrs 

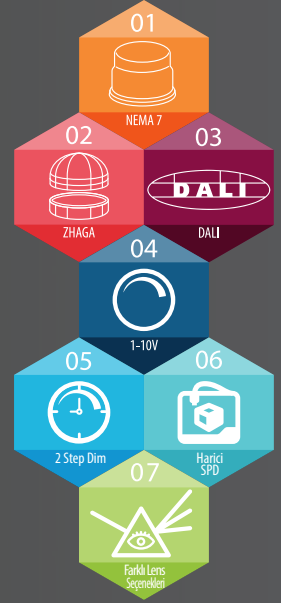

Tool Free Tasarım



Açı Ayarlanabilir Konsol (0° - 5° - 10° - 15°)

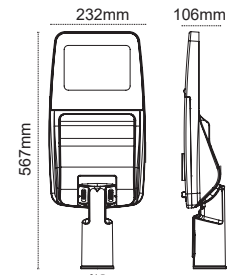
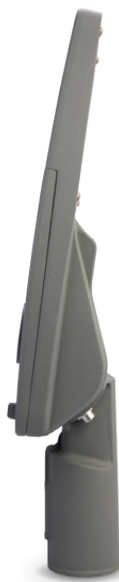

IP 66

Kod No	Özellikler	Koli Adedi	Fiyat
110975	50W 4000K	1	158,00 \$
110974	60W 4000K	1	158,00 \$
110973	80W 4000K	1	170,50 \$
110972	100W 4000K	1	170,50 \$

IP66 LED Yol Aydınlatma Armatürleri **Pelsan**

Rio IP66

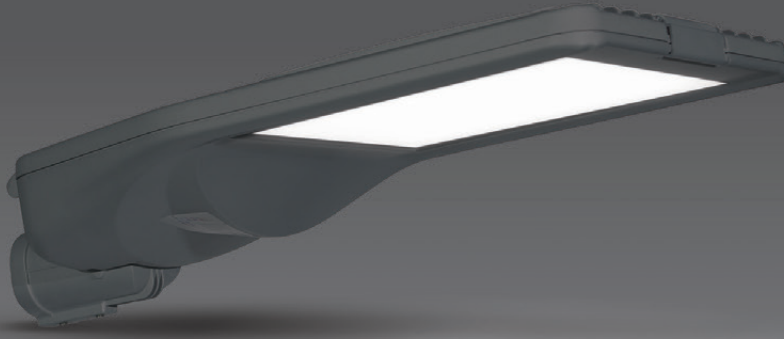

+120 lm/W



LED Çip: L90 @105 °C 86.000 Saat Ömür



ENEC Belgeli LED Sürücü



-35 / +50 °C Çalışma Sıcaklığı



10 kV Yüksek Gerilim Koruması



IK10 Alüminyum Enjeksiyon Gövde



5 Farklı Konsol Açısı

★ ★ Gece Modu Opsiyonu
★ 02:00'den Sonra Otomatik Dim

Rio S IP66

65-150W

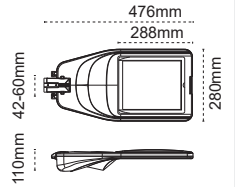

IP 66 3000K 4000K 6500K

Kod No	Özellikler	Koli Adedi	Fiyat
109214	65W 4000K RAL 7043	1	195,80 \$
109169	80W 4000K RAL 7043	1	220,00 \$
109171	100W 4000K RAL 7043	1	220,00 \$
109173	125W 4000K RAL 7043	1	229,50 \$
109175	150W 4000K RAL 7043	1	229,50 \$

Rio M IP66

180-220W

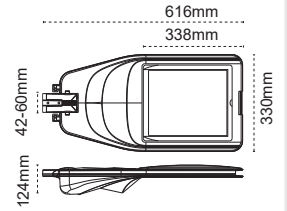

IP 66 3000K 4000K 6500K

Kod No	Özellikler	Koli Adedi	Fiyat
110781	180W 4000K RAL 7043	1	325,00 \$
110782	200W 4000K RAL 7043	1	325,00 \$
110783	220W 4000K RAL 7043	1	325,00 \$

Rio L IP66

240-300W

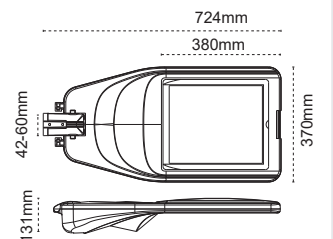

IP 66 3000K 4000K 6500K

Kod No	Özellikler	Koli Adedi	Fiyat
110784	240W 4000K RAL 7043	1	493,00 \$
110785	270W 4000K RAL 7043	1	493,00 \$
110786	300W 4000K RAL 7043	1	493,00 \$

Pelsan LEDli Yol Aydınlatma Armatürleri

Doka G2 IP66



Maksimum Performans İçin...



IP66 Toz ve Su Almaz!



+54.000 Saat Ömür
LED Çip



ENEC Belgeli Driver @Tc - 70°C
100.000 Saat Ömür

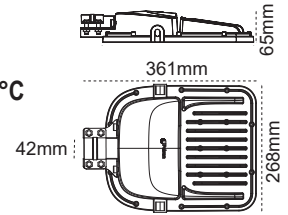

IP 66 4000K 6500K

Kod No	Özellikler	Koli Adedi	Fiyat
111793	60W 4000K	4	121,90 \$
111795	80W 4000K	4	131,10 \$
111797	100W 4000K	4	131,10 \$
111799	150W 4000K	4	173,60 \$

Madrid



Hem Ekonomik, Hem Verimli!

146 lm/W' varan
Etkinlik Faktörü

ürün
videosu



146 lm/W' Varan Etkinlik Faktörü



ENEC Belgeli Sürücü



+50.000 Saat Sistem Ömrü

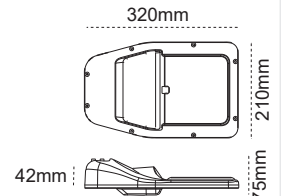

IP 65 4000K 6500K

Kod No	Özellikler	Koli Adedi	Fiyat
109841	20W 4000K	6	49,90 \$
108494	33W 4000K	6	58,00 \$
109877	40W 4000K	6	72,30 \$

Berlin

Ekonomik Fiyat
4 Farklı Güç!

Alüminyum Enjeksiyon Gövde



110 lm / W



IP65, Toz ve Su Almaz!



Berlin
60W

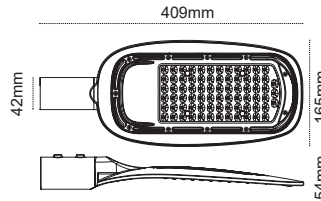

IP 65

Kod No	Özellikler	Koli Adedi	Fiyat
109853	60W 5000K	10	64,70 \$

Berlin
80W

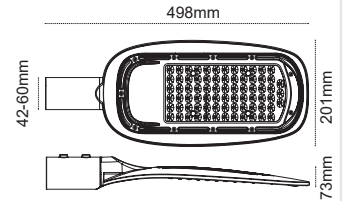

IP 65

Kod No	Özellikler	Koli Adedi	Fiyat
109854	80W 4000K	6	93,40 \$

Berlin
100W

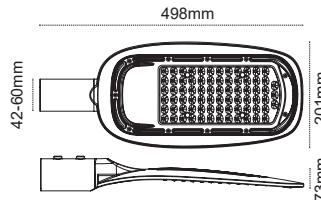

IP 65

Kod No	Özellikler	Koli Adedi	Fiyat
109855	100W 5000K	6	108,00 \$

Berlin
150W

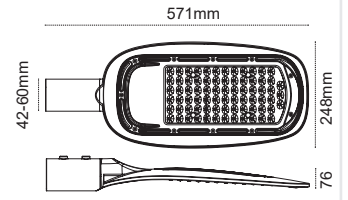

IP 65

Kod No	Özellikler	Koli Adedi	Fiyat
109856	150W 5000K	6	161,70 \$

Pelsan Sokak Armatürleri

Roma Polimer Enjeksiyon

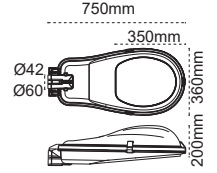

IP 66 ☺ ● 3000K ● 4000K ● 6500K

Kod No	Özellikler	Koli Adedi	Fiyat
104102	250W SB SON-T	2	93,00 \$
104105	400W SB SON-T	2	103,50 \$

Sofia Polimer Enjeksiyon

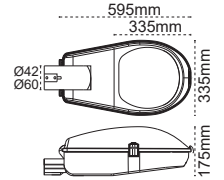

IP 65 ☺

Kod No	Özellikler	Koli Adedi	Fiyat
104077	100W Sodyum SON-T	2	59,80 \$
104081	150W Sodyum SON-T	2	65,30 \$

Riga Polimer Enjeksiyon

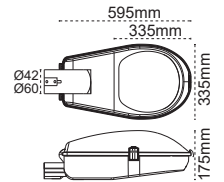

IP 65 ☺

Kod No	Özellikler	Koli Adedi	Fiyat
104062	50W Sodyum SON-T	2	50,30 \$
104064	70W Sodyum SON-T	2	50,50 \$

Aksesuarlar

Kod No	Özellikler	Koli Adedi	Fiyat
311160	Ø60 Direk Tipi Konsol Boru	1	17,20 \$
311157	Set Üstü Konsol 60cm	1	9,80 \$
311156	Duvar Tipi Konsol Boru 30cm Ø42	1	8,30 \$
311151	Konsol Boru 60cm	1	5,70 \$

Kod No	Özellikler	Koli Adedi	Fiyat
311155	Duvar Tipi Konsol Boru 60cm Ø42	1	9,60 \$
311158	Kelepçeli Konsol	1	4,30 \$
301125	60/42 Konsol Adaptörü	1	7,50 \$
310724	Boru Kelepçe	1	0,90 \$

LEDli Park Bahçe Aydınlatma Armatürleri **Pelsan**

Mesaled

W

60W

5260 lm

Alüminyum Gövde

Kamaşma Kontrollü Özel Difüzör

ŞOK FİYAT
277,00\$

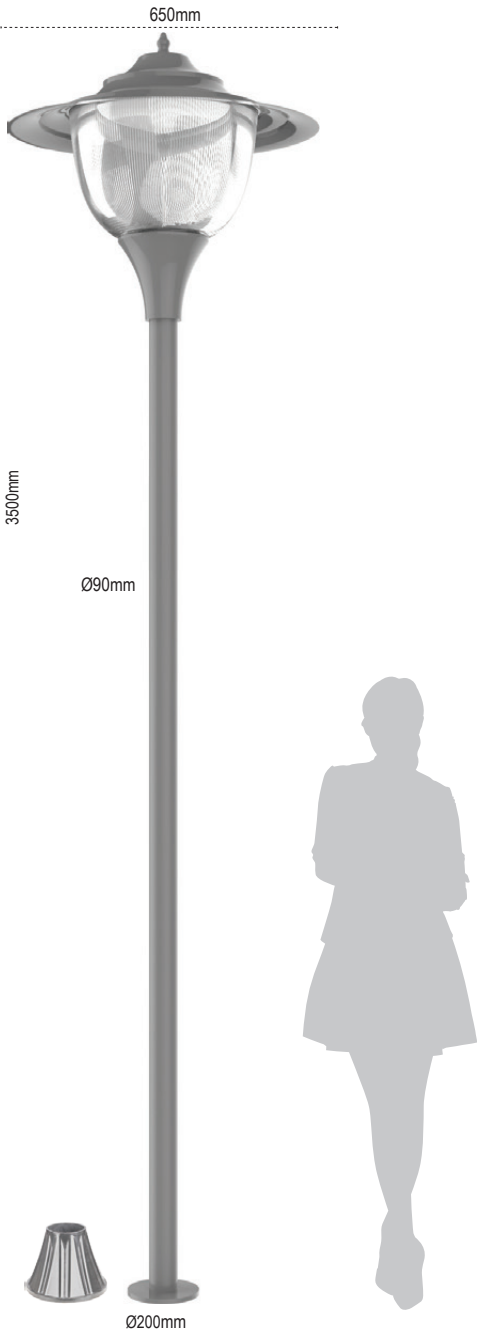

Kamaşma kontrollü özel difüzör



Özel prizmatik difüzör



Kamaşma yapmayan optik dizayn



Yüksek ışık geçirgenliği

Önerilen Uygulama Yüksekliği



4-6 m

Farklı RAL Kodu Uygulaması



RAL9005



RAL9006



RAL7043

Mesaled

IP 54

Kod No	Özellikler	Koli Adedi	Fiyat
108609	30W 4000K	1	277,00 \$
108608	60W 4000K	1	304,70 \$



Pelsan LEDli Park Bahçe Aydınlatma Armatürleri

Olimpos

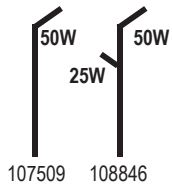
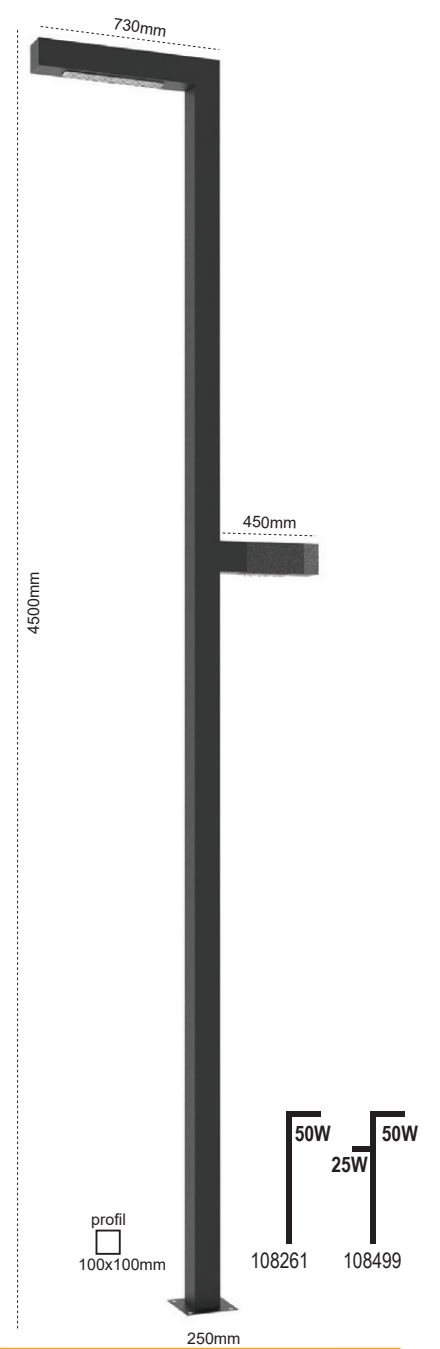
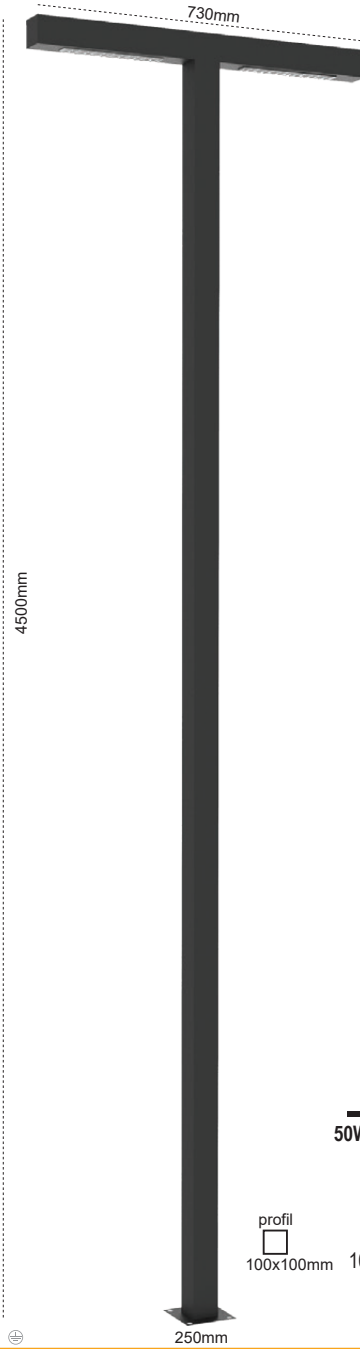
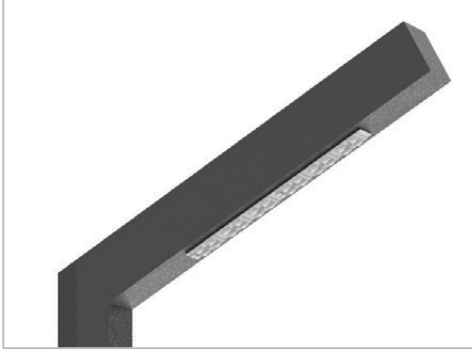

107509 108846



profil
100x100mm

IP 65

250mm

IP 65

250mm

IP 65

250mm

Kod No	Özellikler	Koli Adedi	Fiyat
107509	50W 4000K	1	522,40 \$
108846	50+25W 4000K	1	625,90 \$

Kod No	Özellikler	Koli Adedi	Fiyat
108498	50+50W 4000K	1	731,80 \$
109009	50+50W 4000K	1	731,80 \$

Kod No	Özellikler	Koli Adedi	Fiyat
108261	50W 4000K	1	521,20 \$
108499	50+25W 4000K	1	625,90 \$

Olimpos Med Serisi

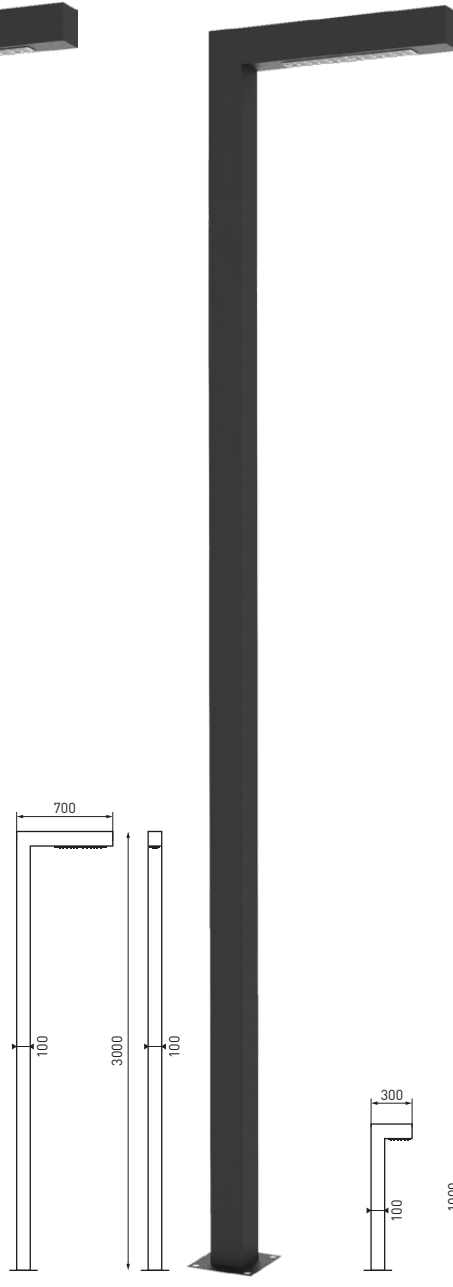
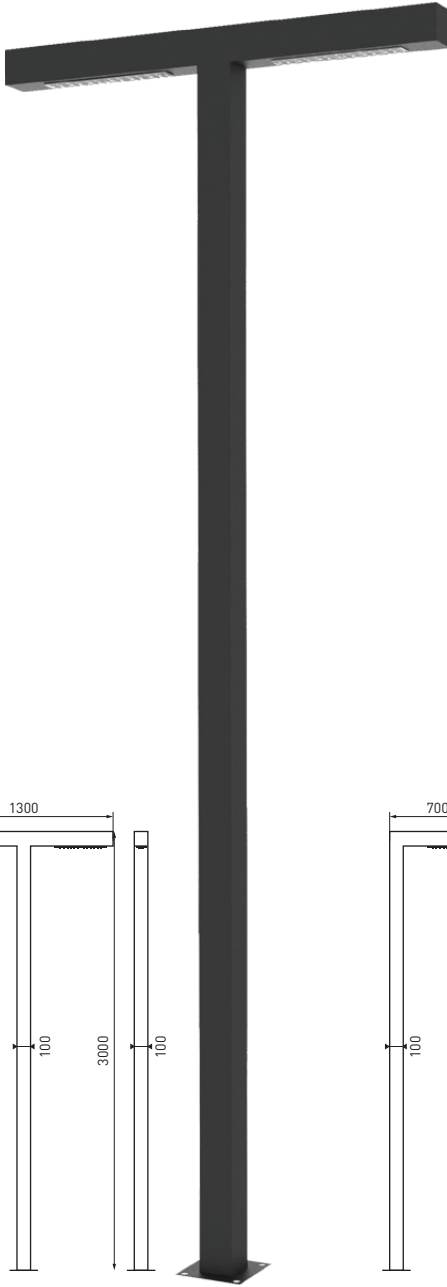

**EKONOMİK
FİYAT**

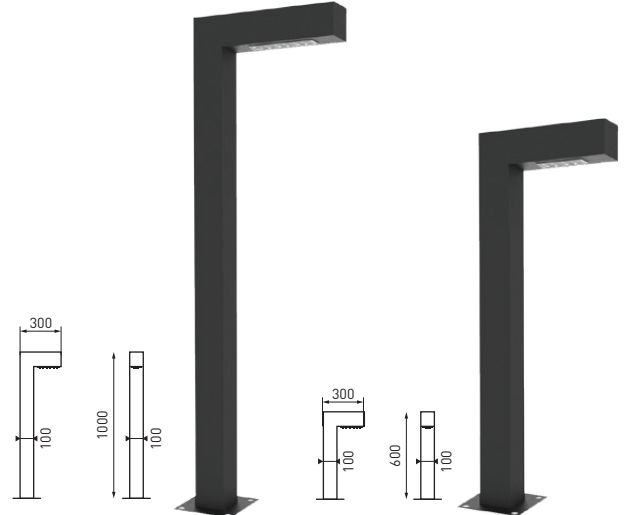

IP 65

Kod No	Özellikler	Koli Adedi	Fiyat
206073	Direk 1x30W 4000K 300cm	1	252,00 \$
206072	Direk 2x30W 4000K 300cm	1	310,00 \$

IP 65

Kod No	Özellikler	Koli Adedi	Fiyat
206074	Bolard 14W 4000K 60cm	1	110,00 \$
206075	Bolard 18W 4000K 100cm	1	123,00 \$

Pelsan LEDli Park Bahçe Aydınlatma Armatürleri

Palmira

109735 4500mm 300x350mm 100x200mm profil 25W 50W 1000mm 650mm TSE

109733 6000mm 300x350mm 100x200mm profil 75W 50W 75W 900mm TSE

109408 6000mm 300x350mm 100x200mm profil 75W 75W 1600mm TSE

Kod No	Özellikler	Koli Adedi	Fiyat
109735	50+25W 4000K	1	974,00 \$

Kod No	Özellikler	Koli Adedi	Fiyat
109733	75W 4000K	1	1.112,70 \$
109734	50+75W 4000K	1	1.353,70 \$

Kod No	Özellikler	Koli Adedi	Fiyat
109408	75+75W 4000K	1	1.512,20 \$

LEDli Park Bahçe Aydınlatma Armatürleri **Pelsan**

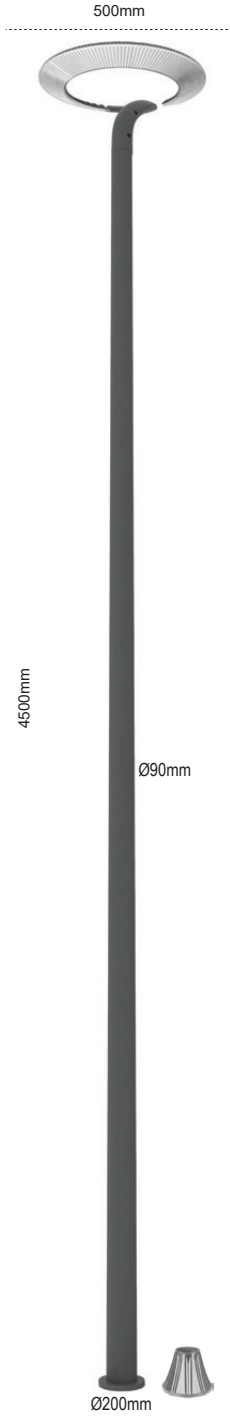

Aperla

Kod No	Özellikler	Koli Adedi	Fiyat
109741	60W 4000K	1	533,30 \$

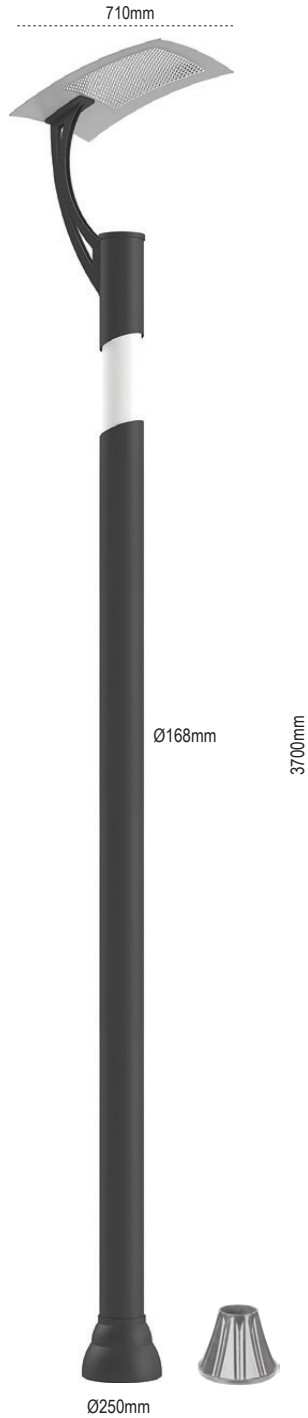

Datça

Kod No	Özellikler	Koli Adedi	Fiyat
107619	150W G12	1	533,30 \$
107601	30W LED 4000K	1	666,70 \$

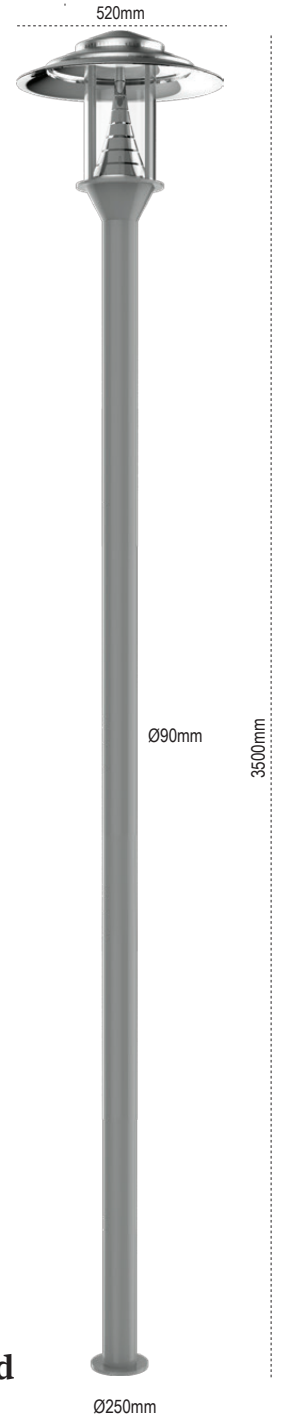

Evaled

Kod No	Özellikler	Koli Adedi	Fiyat
108610	40W LED 4000K	1	504,40 \$

Pelsan LEDli Park Bahçe Aydınlatma Armatürleri



500mm



710mm



700mm

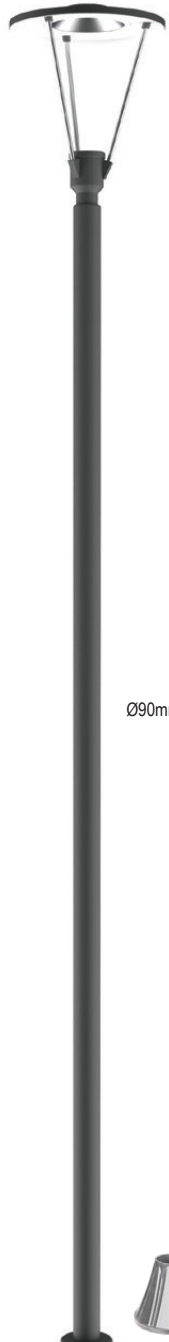

Ø90mm

4500mm

Ø250mm

Petra

IP 65

Kod No	Özellikler	Koli Adedi	Fiyat
107882	50W 4000K	1	433,30 \$

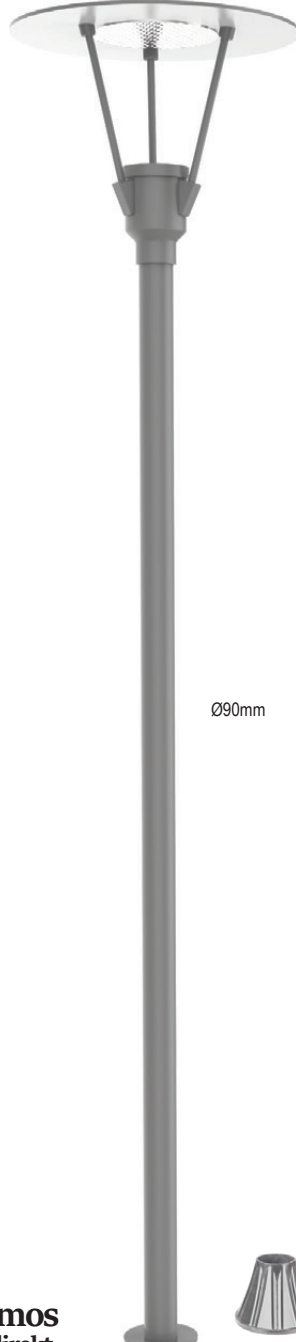

Ø90mm

4500mm

Ø250mm

Samos Endirekt

IP 65

Kod No	Özellikler	Koli Adedi	Fiyat
108612	150W G12	1	533,30 \$
108163	50W LED 4000K	1	633,30 \$

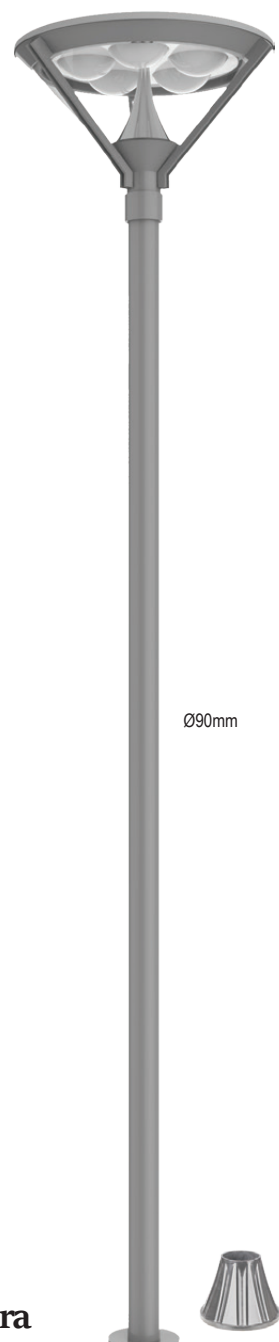

Ø90mm

4500mm

Ø250mm

Limra

IP 54

Kod No	Özellikler	Koli Adedi	Fiyat
107416	150W E40	1	400,00 \$
108606	38W LED 4000K 3'lü	1	480,00 \$
108605	80W LED 4000KA 5'li	1	624,00 \$

Yeni LEDli Park Bahçe Aydınlatma Armatürleri **Pelsan**



Ø200mm



120mm



120mm

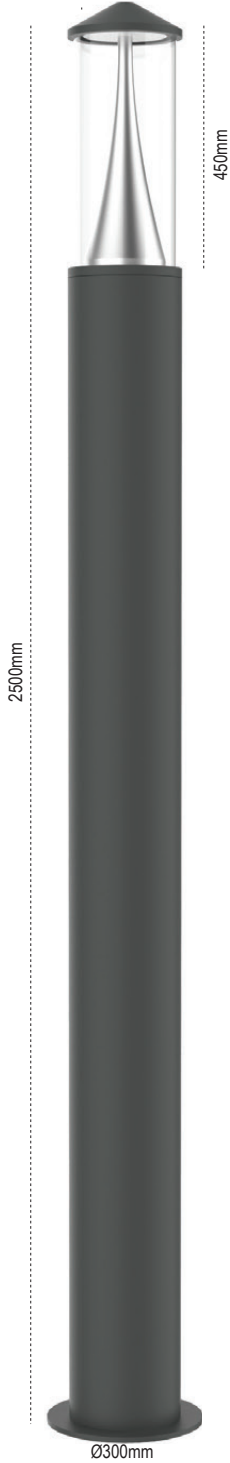

2500mm

450mm

Ø300mm

Luzon

IP 54

Kod No	Özellikler	Koli Adedi	Fiyat
109736	40W 4000K	1	444,00 \$

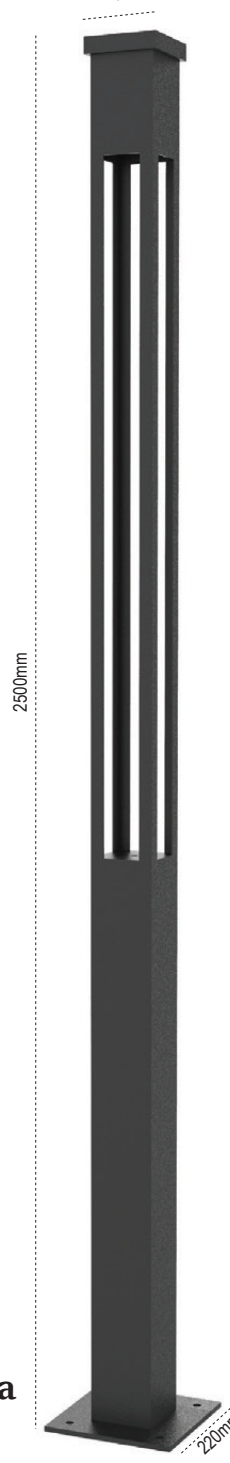

2500mm

220mm

Alinda

IP 54

Kod No	Özellikler	Koli Adedi	Fiyat
107467	35W 4000K	1	276,00 \$

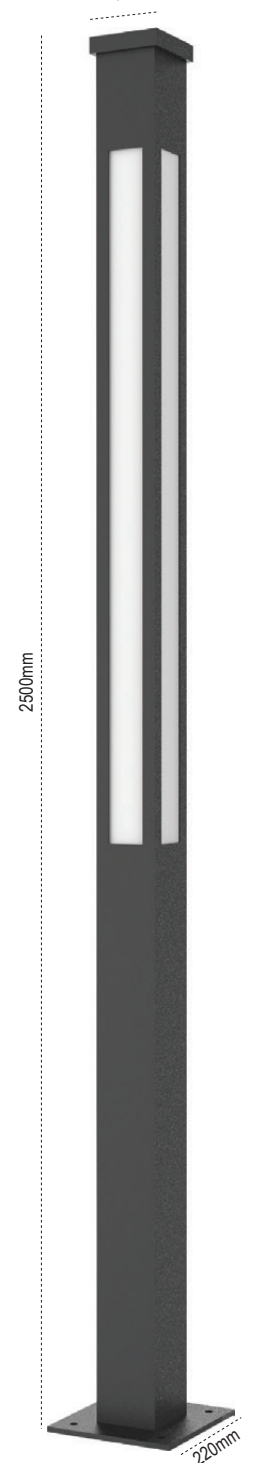

2500mm

220mm

Milas

IP 54

Kod No	Özellikler	Koli Adedi	Fiyat
108500	100W 4000K	1	690,00 \$

Pelsan Park Bahçe Aydınlatma Armatürleri

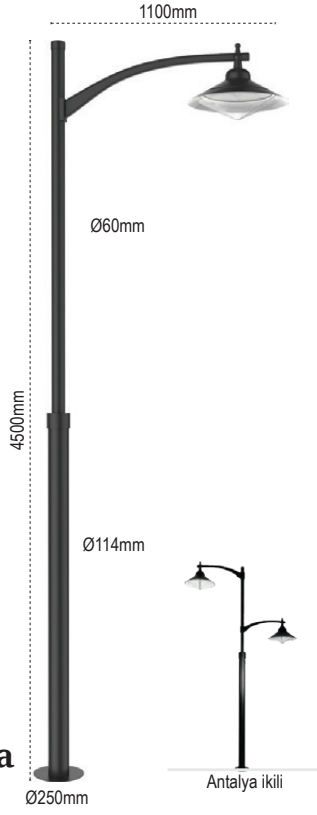

Antalya

IP 54 ☺

Kod No	Özellikler	Koli Adedi	Fiyat
107531	Tekli Direk E27	1	271,30 \$
107532	İkili Direk E27	1	336,70 \$

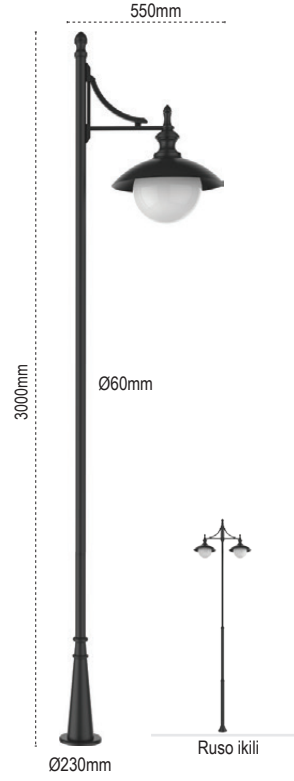

Ruso

IP 54 ☺

Kod No	Özellikler	Koli Adedi	Fiyat
107461	Tekli Döküm Dipli Direk E27	1	239,70 \$
107463	İkili Döküm Dipli Direk E27	1	320,70 \$

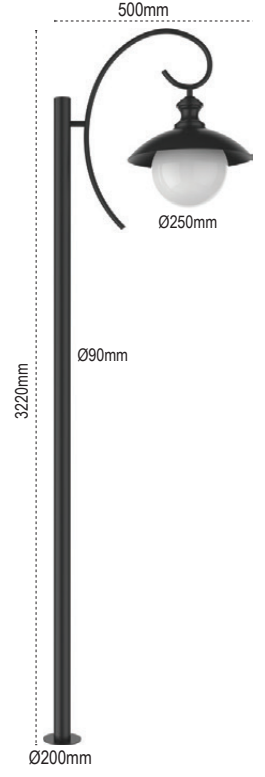

Uruse

IP 54 ☺

Kod No	Özellikler	Koli Adedi	Fiyat
107510	Tekli E27	1	157,60 \$

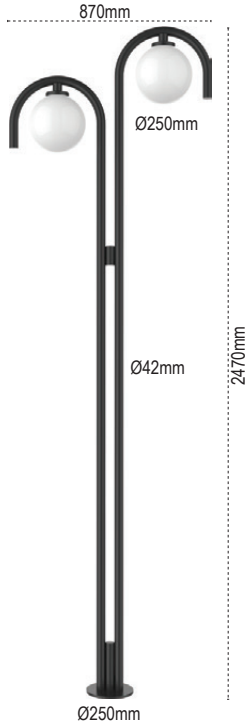

Perge

IP 54 ☺

Kod No	Özellikler	Koli Adedi	Fiyat
107543	İkili E27	1	165,40 \$

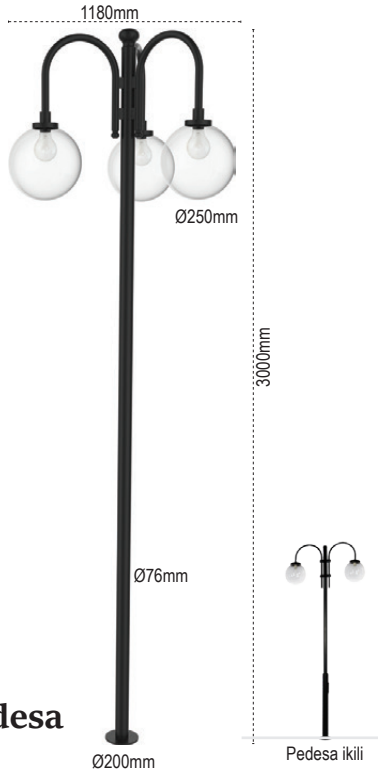

Pedesa

IP 54 ☺

Kod No	Özellikler	Koli Adedi	Fiyat
107533	Tekli Gloplu Direk E27	1	120,40 \$
107517	İkili Gloplu Direk E27	1	200,30 \$
107530	Üçlü Gloplu Direk E27	1	284,70 \$

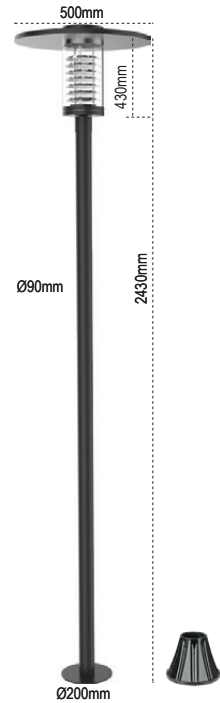

Arta

IP 54 ☺

Kod No	Özellikler	Koli Adedi	Fiyat
107591	Arta Boru Direk Arm. E27	1	258,80 \$

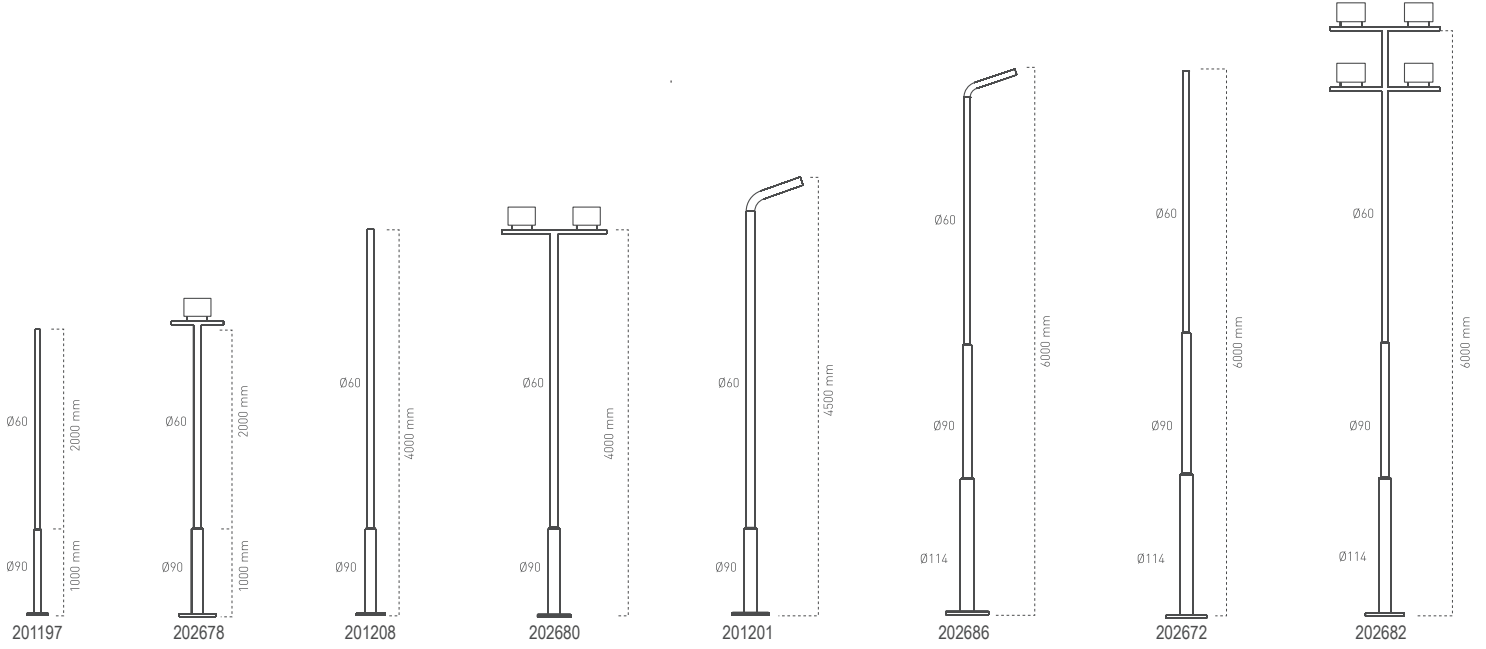

Yol, Bahçe ve Projektör Direkleri

IP 65

Kod No	Özellikler	Koli Adedi	Fiyat	Kod No	Özellikler	Koli Adedi	Fiyat
201197	3 m Kademeli Boru Direk	1	120,00 \$	201201	4,5 m S. Lamba Direği	1	157,00 \$
202678	3 m 1 Projektörlük Boru Direk	1	129,30 \$	202686	6 m S. Lamba Direği	1	249,30 \$
201208	4 m Kademeli Boru Direk	1	138,50 \$	202672	6 m Kademeli Boru Direk	1	249,30 \$
202680	4 m 2 Projektörlük Direk	1	147,70 \$	202682	6 m 4 Projektörlük Direk	1	267,80 \$
				312688	Ankraj 250mm Polyester	1	11,00 \$

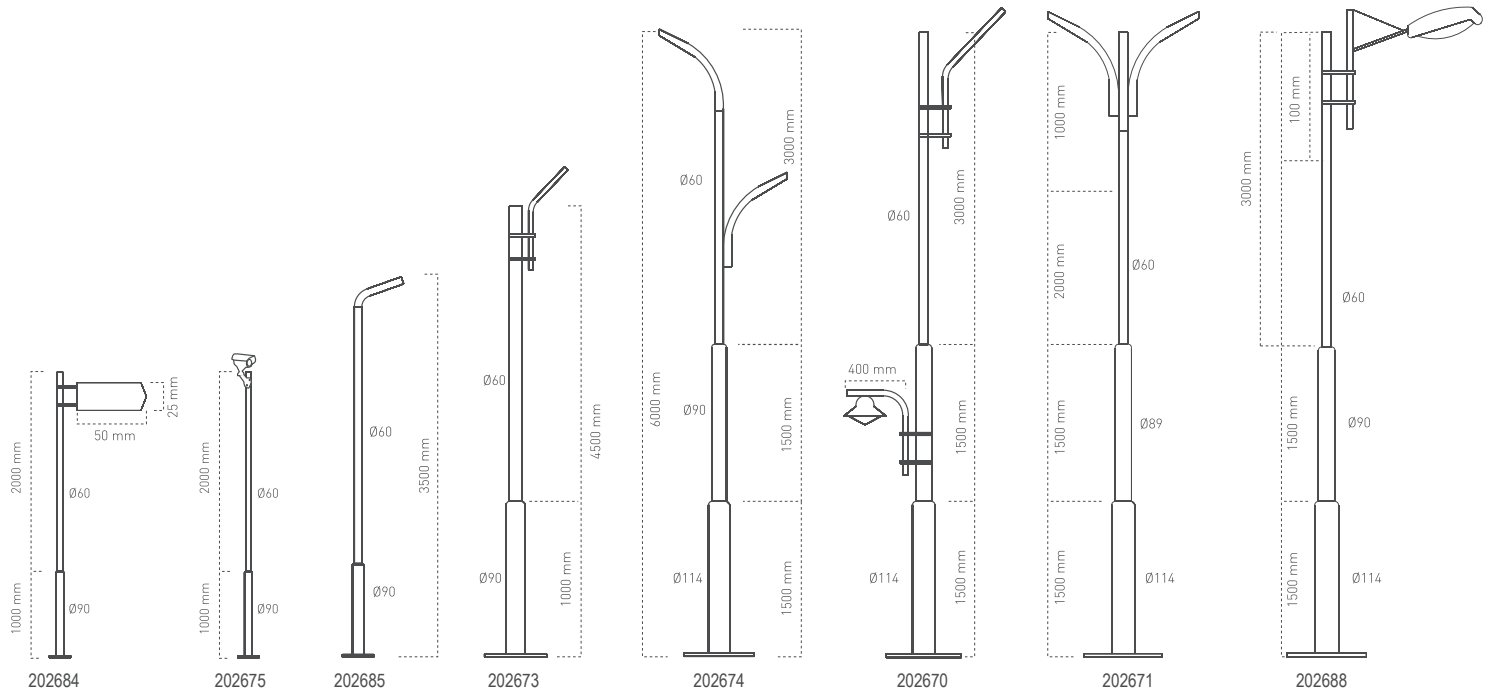

Yol, Bahçe ve Projektör Direkleri

IP 65

Kod No	Özellikler	Koli Adedi	Fiyat	Kod No	Özellikler	Koli Adedi	Fiyat
202684	3 m Sokak Direği	1	83,10 \$	202674	6 m 2xArmatür	1	267,80 \$
202675	3 m Kamera Direği	1	101,60 \$	202670	6 m Çift Armatür Direği	1	286,20 \$
202685	3,5 m Sokak Lamba Direği	1	142,20 \$	202671	6 m 2xKonsol Direği	1	267,80 \$
202673	4,5 m 1 x Armatür Direği	1	157,00 \$	202688	6 m Armatür Direği	1	249,30 \$
312688	Ankraj 250mm Polyester	1	11,00 \$				

Pelsan Bolardlar



Alcatra

IP 65 ☹

Kod No	Özellikler	Koli Adedi	Fiyat
108856	18W 4000K	1	133,30 \$

Dominik

IP 65 ☹

Kod No	Özellikler	Koli Adedi	Fiyat
108866	2x18W 4000K	1	177,40 \$

Tahiti

IP 65 ☹

Kod No	Özellikler	Koli Adedi	Fiyat
108868	18W 4000K	1	133,30 \$

Mikanos

IP 65 ☹

Kod No	Özellikler	Koli Adedi	Fiyat
108869	2x18W 4000K	1	177,40 \$



Bali

IP 65 ☹

Kod No	Özellikler	Koli Adedi	Fiyat
108870	18W 4000K	1	133,30 \$

Malta

IP 65 ☹

Kod No	Özellikler	Koli Adedi	Fiyat
108871	2x18W 4000K	1	177,40 \$

Maldiv

IP 65 ☹

Kod No	Özellikler	Koli Adedi	Fiyat
108872	18W 4000K	1	133,30 \$

Santorini

IP 65 ☹

Kod No	Özellikler	Koli Adedi	Fiyat
108873	2x18W 4000K	1	177,40 \$



Pega

IP 54 ☺

Kod No	Özellikler	Koli Adedi	Fiyat
108878	18W 4000K	1	111,10 \$

Mayorka

IP 54 ☺

Kod No	Özellikler	Koli Adedi	Fiyat
111419	10W 4000K	1	177,40 \$

Luzon

IP 54 ☺

Kod No	Özellikler	Koli Adedi	Fiyat
109027	20W 4000K	1	140,40 \$

Luzon 2

IP 54 ☺

Kod No	Özellikler	Koli Adedi	Fiyat
110753	14W 4000K	1	92,30 \$



Hawaii

IP 65 ☺

Kod No	Özellikler	Koli Adedi	Fiyat
108874	20W 4000K	1	148,70 \$

Bahama

IP 65 ☺

Kod No	Özellikler	Koli Adedi	Fiyat
108875	2x20W 4000K	1	177,40 \$

Capri

IP 65 ☺

Kod No	Özellikler	Koli Adedi	Fiyat
108876	20W 4000K	1	143,80 \$

Phuket

IP 65 ☺

Kod No	Özellikler	Koli Adedi	Fiyat
108877	2x20W 4000K	1	177,40 \$



Antalya

Kod No	Özellikler	Koli Adedi	Fiyat
107588	E27 Duyulu	1	90,10 \$



Perge

Kod No	Özellikler	Koli Adedi	Fiyat
107585	E27 Duyulu	1	62,90 \$



Alinda

Kod No	Özellikler	Koli Adedi	Fiyat
108859	18W 4000K	1	153,30 \$

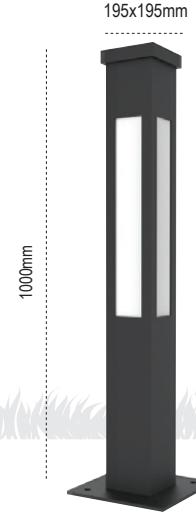

Milas

Kod No	Özellikler	Koli Adedi	Fiyat
107580	E27 Duyulu	1	180,50 \$
107586	20W 4000K	1	279,90 \$

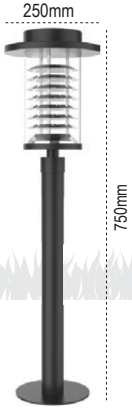

Arta

Kod No	Özellikler	Koli Adedi	Fiyat
107565	E27 Duyulu	1	83,20 \$

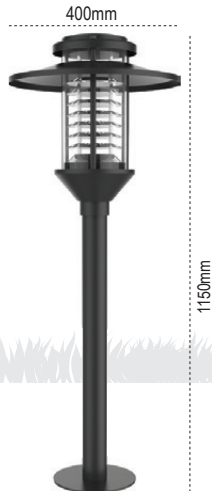

Eva

Kod No	Özellikler	Koli Adedi	Fiyat
107560	E27 Duyulu	1	120,50 \$



Noa

Kod No	Özellikler	Koli Adedi	Fiyat
107578	E27 Duyulu	1	57,80 \$

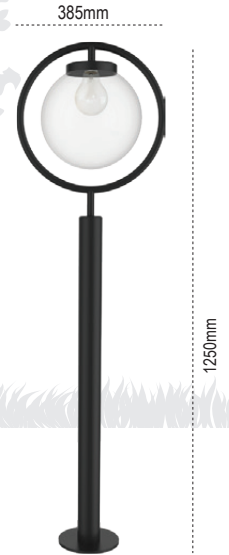

Pedesa

Kod No	Özellikler	Koli Adedi	Fiyat
107564	E27 Duyulu	1	54,60 \$

10W Dış Mekan Spotu
Erbaled

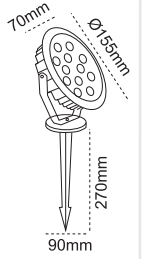
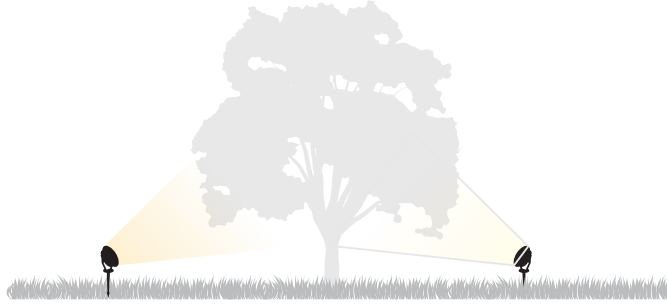

IP 65

IP 65

Kod No	Özellikler	Koli Adedi	Fiyat
109359	10W 4000K	8	41,60 \$
109487	10W 6500K	8	41,60 \$
205288	Saplama Aparatı 21cm	10	4,60 \$

Kod No	Özellikler	Koli Adedi	Fiyat
109359	10W 4000K	8	41,60 \$
109487	10W 6500K	8	41,60 \$
205288	Saplama Aparatı 21cm	10	4,60 \$

Grassled G2
Monoled

Yeni Ürün

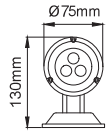

IP 65

Kod No	Özellikler	Koli Adedi	Fiyat
205616	3W 4000K	1	33,80 \$

Yer Gömme
Monoled

Yeni Ürün



IP 67

Kod No	Özellikler	Koli Adedi	Fiyat
205992	3W 4000K	1	131,00 \$

Yer Gömme
Duoled

Yeni Ürün

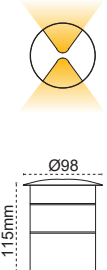

IP 67

Kod No	Özellikler	Koli Adedi	Fiyat
205995	3W 4000K	1	140,00 \$

Yer Gömme
Ø80

Yeni Ürün

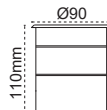

IP 67

● 3000K ● 4000K ● 6500K

Kod No	Özellikler	Koli Adedi	Fiyat
205998	3W 4000K	1	107,50 \$

Yer Gömme
Ø100

Yeni Ürün

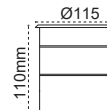

IP 67

● 3000K ● 4000K ● 6500K

Kod No	Özellikler	Koli Adedi	Fiyat
206001	6W 4000K	1	133,50 \$

Yer Gömme
Ø150

Yeni Ürün

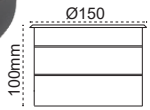

IP 67

● 3000K ● 4000K ● 6500K

Kod No	Özellikler	Koli Adedi	Fiyat
206004	9W 4000K	1	197,50 \$
206007	18W 4000K	1	197,50 \$
206010	27W 4000K	1	197,50 \$

Duvar Gömme
Oscaled

Yeni Ürün



IP 65

Kod No	Özellikler	Koli Adedi	Fiyat
206013	3W 4000K	1	73,50 \$

Duvar Gömme
Escaled

Yeni Ürün

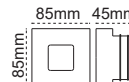
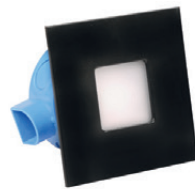

IP 65

Kod No	Özellikler	Koli Adedi	Fiyat
205989	3W 4000K	1	77,50 \$

Yer Gömme
Miniled 3'lü

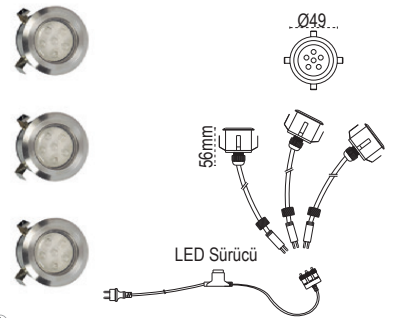

IP 65

Kod No	Özellikler	Koli Adedi	Fiyat
204266	LEDli Mavi	12	25,00 \$

Pelsan Dış Mekan Aplikleri

Işıl 1



Alüminyum
Enjeksiyon

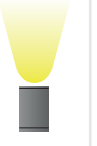

IP 54

Kod No Özellikler
110742 1xE27 Duyulu

Koli Adedi Fiyat
8 29,60 \$

Işıl 2



Alüminyum
Enjeksiyon



IP 54

Kod No Özellikler
110743 2xE27 Duyulu

Koli Adedi Fiyat
6 40,70 \$

Tibat 1



Alüminyum
Enjeksiyon



IP 54

Kod No Özellikler
110744 E27 Duyulu

Koli Adedi Fiyat
8 31,70 \$

Tibat 2



Alüminyum
Enjeksiyon



IP 54

Kod No Özellikler
110745 2XE27 Duyulu

Koli Adedi Fiyat
6 44,30 \$

Mova
Sensörlü

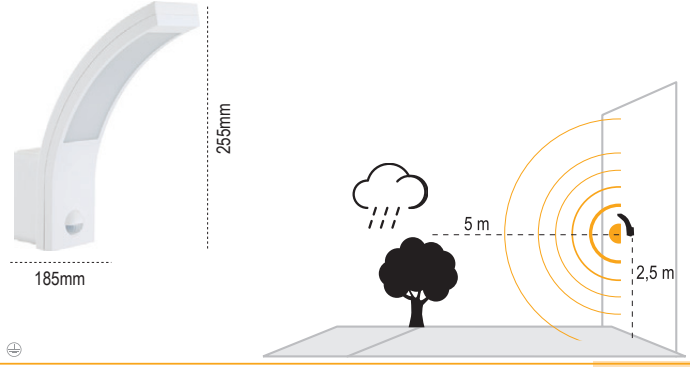

IP 54

Kod No	Özellikler	Koli Adedi	Fiyat
109228	10W 6500K Sensörlü	8	28,50 \$

Mova
Sensörlü

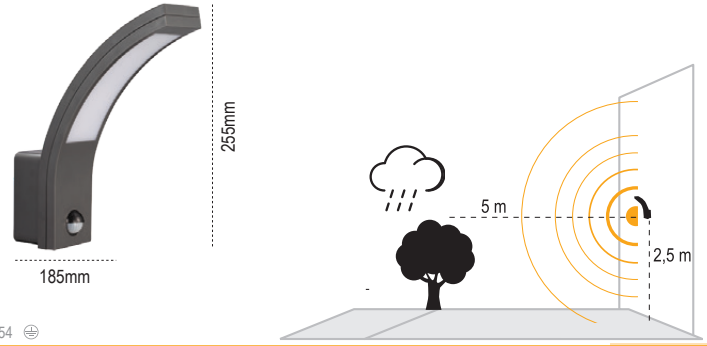

IP 54

Kod No	Özellikler	Koli Adedi	Fiyat
110324	10W 4000K Sensörlü	6	28,50 \$

Işıközü
Sensörlü

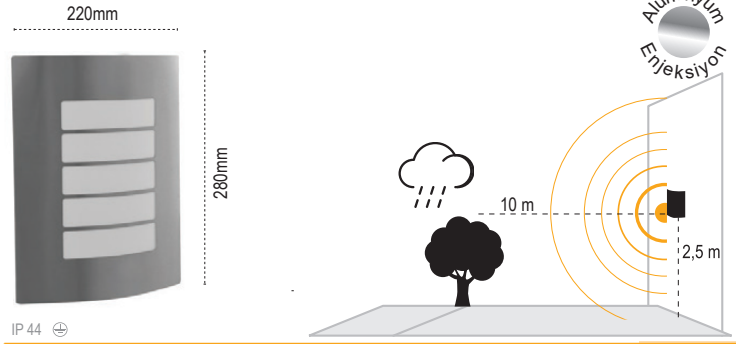

IP 44

Kod No	Özellikler	Koli Adedi	Fiyat
109297	E27 Duyulu Sensörlü	8	27,20 \$

Havana G2
IP66



IP 66

Kod No	Özellikler	Koli Adedi	Fiyat
111193	E27	8	16,50 \$
111194	2XE27	8	17,60 \$
111220	E27 Sensörlü	8	30,50 \$
111223	2XE27 E27 Sensörlü	8	31,60 \$
111226	15W 6500K	8	29,60 \$
111236	15W 6500K Sensör	8	43,60 \$
111245	15W 6500K Acil Ayd Kit	8	55,60 \$
111260	15W 6500K Sensör + Acil Ayd Kit	8	69,60 \$

Pelsan Set Üstü Armatürler

Cubo



IP 54 ☉

220mm
270mm

Kod No	Özellikler	Koli Adedi	Fiyat
204423	E27	6	52,90 \$

Alinda



IP 54 ☉

200mm
310mm

Kod No	Özellikler	Koli Adedi	Fiyat
109401	15W 4000K	8	86,80 \$

Pega



IP 65 ☉

Ø200mm
310mm

Kod No	Özellikler	Koli Adedi	Fiyat
109403	15W 4000K	2	87,50 \$

Tura



IP 54 ☉

300mm
265mm

Kod No	Özellikler	Koli Adedi	Fiyat
109445	4xE27 Duyulu	8	145,50 \$

Canaria



IP 54 ☉

235mm
305mm

Kod No	Özellikler	Koli Adedi	Fiyat
109423	4xE27 Duyulu	8	138,50 \$

Elba



IP 54 ☉

235mm
305mm

Kod No	Özellikler	Koli Adedi	Fiyat
109437	4xE27 Duyulu	8	110,80 \$

Luzon



IP 54 ☉

Ø260mm
325mm

Kod No	Özellikler	Koli Adedi	Fiyat
109402	15W 4000K	1	97,70 \$

Vedra



IP 54 ☉

Ø200mm
270mm

Kod No	Özellikler	Koli Adedi	Fiyat
109444	4xE27 Duyulu	8	122,40 \$

Tino



IP 54 ☉

Ø170mm
310mm

Kod No	Özellikler	Koli Adedi	Fiyat
110709	E27 Duyulu	8	38,80 \$

Hawai



IP 65 ☉

225mm
250mm

Kod No	Özellikler	Koli Adedi	Fiyat
109438	15W 4000K	8	105,30 \$

Arta



Ø90mm
Ø150mm
250mm
500mm

IP 54 ☉

Kod No	Özellikler	Koli Adedi	Fiyat
107447	E27 Duyulu	6	86,80 \$

Eva



Ø76mm
Ø150mm
320mm
500mm

IP 54 ☉

Kod No	Özellikler	Koli Adedi	Fiyat
107453	E27 Duyulu	6	81,60 \$

İç Mekan LED Şerit Üç Çip IP20

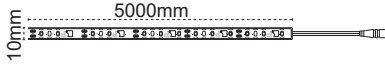

Ömrü Boyunca Aynı Işık Çıktısı

- 30.000 saat ömür
- Her 3 modülde bir kesilebilme
- 3M Bant
- 12V DC ile çalışır

12V DC IP 20

Kod No	Özellikler	Koli Adedi	Fiyat
205365	IP20 SMD LED 3000K 5 metre	100	4,50 \$
205366	IP20 SMD LED 4000K 5 metre	100	4,50 \$
205367	IP20 SMD LED 6500K 5 metre	100	4,50 \$

12V IP20 Sabit Gerilim Sürücüler



313248



IP 20

Kod No	Özellikler	Koli Adedi	Fiyat
313240	60W 12V 5A	50	7,50 \$
313242	100W 12V 8,5A	40	9,80 \$
313244	150W 12V 12,5A	60	13,40 \$
313246	200W 12V 16,5A	36	15,90 \$
313252	250W 12V 21A	30	19,00 \$
313248	360W 12V 30A	30	22,50 \$

Neon LED



Aparatlar fiyata dahildir.

- Fişli Kablo (1 Adet)
- Birleştirme Aparatı (1 Adet)
- Sonlandırma Aparatı (1 Adet)

Ultra Esnek! Ultra Parlak!



Ultra Esnek!

Pelsan Neon LED özel silikon ve flexible PCB'si sayesinde **ultra esnekliğe** sahiptir.



Kullanım Kolaylığı!

Metrede bir kesilebilir.



Ultra Parlak!

Özel silikon yapısı ışığın homojenize olmasını sağlarken **ultra parlaklık sunar.**



220-240V AC ile çalışır. Kullanımı kolaydır. 50 metreye kadar kesintisiz kullanılır.



Toz ve Su Almaz!

IP65 koruma sınıfı ile dış mekanda kullanılır.

Kod No	Özellikler	Koli Adedi	Fiyat
205251	Neon LED 3000K 25m	1	142,80 \$
205258	Neon LED 5500K 25m	1	142,80 \$
205254	Neon LED Amber 25m	1	142,80 \$

Neon Aksesuarlar



203724



203725



203726



203728

Kod No	Özellikler	Koli Adedi	Fiyat	Kod No	Özellikler	Koli Adedi	Fiyat
203724	Neon LED Birleştirme Aparatı (10'lu)	1	7,90 \$	203726	Neon LED Bağlantı Aparatı (Fişli Kablolu)	1	8,60 \$
203728	Neon LED Sonlandırma Aparatı (10'lu)	1	4,60 \$	203725	Neon LED Alüminyum Montaj Aparatı (5 cm)	(10'lu)	11,30 \$

Pelsan LED Lambalar

LED Lambalar



4W

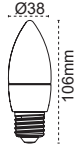

5W



9W

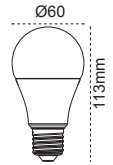

Kod No	Özellikler	Koli Adedi	Fiyat	Kod No	Özellikler	Koli Adedi	Fiyat	Kod No	Özellikler	Koli Adedi	Fiyat
313396	4W 6500K E27 Ø38	100	0,99 \$	315105	5W 2700K E27 Ø45	100	0,99 \$	313411	9W 2700K E27 Ø60	100	0,99 \$
				315106	5W 6400K E27 Ø45	100	0,99 \$	313415	9W 6400K E27 Ø60	100	0,99 \$

Yüksek Güçlü Lambalar



18W

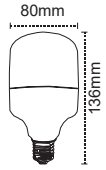

28W

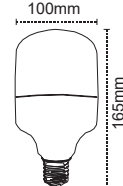

38W

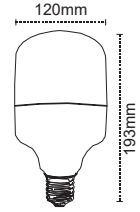

Kod No	Özellikler	Koli Adedi	Fiyat	Kod No	Özellikler	Koli Adedi	Fiyat	Kod No	Özellikler	Koli Adedi	Fiyat
317863	18W 6500K E27	30	5,00 \$	313420	28W 6500K E27	20	7,05 \$	313421	38W 6500K E27	20	9,05 \$

Spot / Buji / Acil LED Lambalar



Buji
LED Lamba

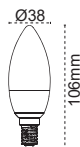

Par Lamba

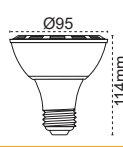

Şarj Edilebilir
LED Lamba

3 saat
Acil Durum
Aydınlatma

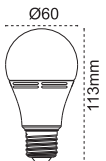

Kod No	Özellikler	Koli Adedi	Fiyat	Kod No	Özellikler	Koli Adedi	Fiyat	Kod No	Özellikler	Koli Adedi	Fiyat
313395	4W 2700K E14 Ø38	100	1,56 \$	313408	12X1W PAR38 Lamba 4000K E27	20	10,40 \$	315107	9W 6500K E27	50	6,50 \$
				313409	12X1W PAR38 Lamba 6500K E27	20	10,40 \$				

**Filament Lamba
(T20)**

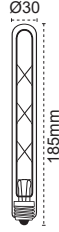

Kod No	Özellikler	Koli Adedi	Fiyat
318053	6W 2700K E27 T20	20	6,60 \$

**Filament Lamba
(Ø64)**

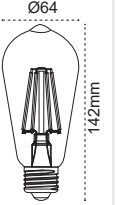

Kod No	Özellikler	Koli Adedi	Fiyat
313440	6W Filament E27 2700K	40	3,70 \$

**Filament Lamba
(Ø95)**

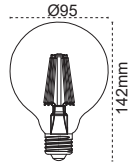

Kod No	Özellikler	Koli Adedi	Fiyat
313441	6W Filament E27 2700K	20	5,50 \$

**Filament Lamba
(Ø125)**

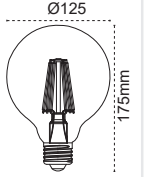

Kod No	Özellikler	Koli Adedi	Fiyat
313442	6W Filament E27 2700K	20	7,60 \$

**Filament Lamba
(Ø60)**

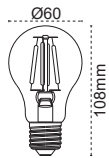

Kod No	Özellikler	Koli Adedi	Fiyat
313438	4W Filament Lamba E27 3000K	100	2,25 \$
313444	4W Filament Lamba E27 6500K	100	2,25 \$

Buji Filament Lamba

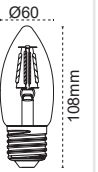

Kod No	Özellikler	Koli Adedi	Fiyat
313437	4W Buji Lamba E27 3000K	100	2,05 \$
313439	4W Buji Lamba E27 6500K	100	2,05 \$

Pelsan LED Tube

LED Tube Pro



Döner Başlık



130lm/W



ABS Gövde

Kod No	Özellikler	Koli Adedi	Fiyat
319184	16W 6500K 120cm 140 lm/W	25	11,30 \$
323524	22W 6500K 150cm 135 lm/W	25	16,50 \$

LED Tube Cam Gövde



Tek Taraftan
Bağlantı



A+ Enerji
Tasarrufu



Kolay
Kurulum



60 / 120 / 150 cm
Boy Seçeneği

Kod No	Özellikler	Koli Adedi	Fiyat	Kod No	Özellikler	Koli Adedi	Fiyat
314663	9W 4000K 60cm	25	4,79 \$	314669	22W 4000K 150cm	25	10,10 \$
314664	9W 6500K 60cm	25	4,79 \$	314668	22W 6500K 150cm	25	10,10 \$
315112	18W 4000K 120cm	25	5,31 \$				
314665	18W 6500K 120cm	25	5,31 \$				

Sensörlü LED Tube ABS Gövde LED Tube



Çift Taraftan
Bağlantı



Çalışma Şekli

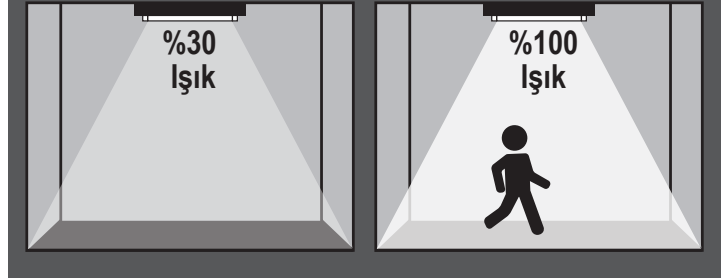

Kod No	Özellikler	Koli Adedi	Fiyat
315115	18W Sensör 6500K 120cm	25	14,40 \$

LED Tube Acil (1,5 saat) Cam Gövde LED Tube



Çift Taraftan
Bağlantı



Çalışma Şekli

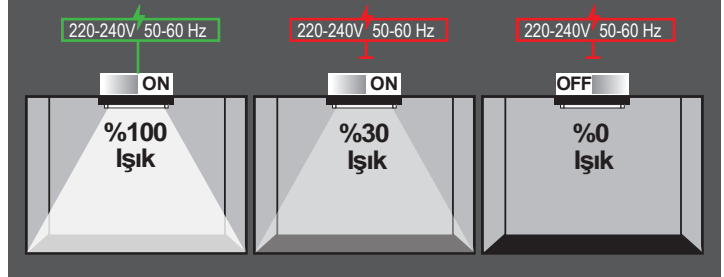

Kod No	Özellikler	Koli Adedi	Fiyat
315116	18W Acil 6500K 120cm	25	17,50 \$

Y.B Metal Halide

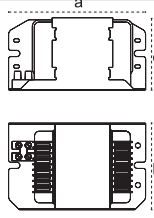

IP 40

Kod No	Özellikler	axbxcmm	Koli Adedi	Fiyat
313048	Metal Halide 35W	155x42x33	24	14,10 \$
313051	Metal Halide 70W	116x64x54	16	20,25 \$
313052	Metal Halide 150W	122x78x66	8	30,65 \$
313053	Metal Halide 250W	135x93x79	4	47,90 \$
313055	Metal Halide 400W	135x93x79	4	50,40 \$
313057	Metal Halide 1000W	197x126x138	2	136,00 \$
313059	Metal Halide 2000W (380V)	225x126x138	1	176,75 \$

Y.B Sodyum Halide

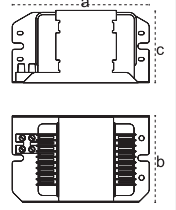

IP 40

Kod No	Özellikler	axbxcmm	Koli Adedi	Fiyat
313043	Sodyum Buharlı 400W	156x93x69	2	66,00 \$
313047	Sodyum Buharlı 600W	178x126x138	2	107,85 \$
313045	Sodyum Buharlı 1000W	197x126x138	2	136,00 \$

Metal Kitler

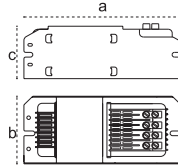

IP 20

Kod No	Özellikler	axbxcmm	Koli Adedi	Fiyat
200078	Metal Kit 35W Balast + ignitör	185x115x88	4	29,70 \$
200069	Metal Kit 70W Balast + ignitör	150x64x54	4	31,50 \$
200070	Metal Kit 150W Balast + ignitör	166x77x65	4	45,75 \$
200074	Metal Kit 250W Balast + ignitör	205x93x79	4	59,00 \$
200076	Metal Kit 400W Balast + ignitör	232x93x79	4	62,60 \$
105227	Olimpiad Kiti 1000W	246x126x138	1	198,00 \$

Sera Kitler

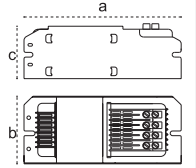

IP 20

Kod No	Özellikler	axbxcmm	Koli Adedi	Fiyat
200066	Sera 400W SB Balast Kiti	232x93x79	4	95,00 \$
200067	Sera 600W SB Balast Kiti	246x126x138	1	160,00 \$

Silver Floresant Balast

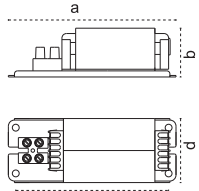

IP 40

Kod No	Özellikler	axbxcxdmm	Koli Adedi	Fiyat
312959	15W TLD	100x32,2x87x42	36	7,00 \$
312969	20W TLD	100x32,2x87x42	36	7,00 \$
312975	32W TLD	100x32,2x87x42	36	7,00 \$
312971	36-40W TLD	100x32,2x87x42	36	7,00 \$

Elektronik Balast

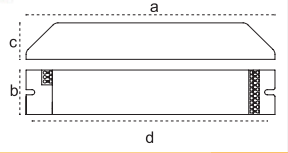

IP 40

Kod No	Özellikler	axbxcxdmm	Koli Adedi	Fiyat
313142	1X18W TLD	295x31x29x285	10	12,00 \$
313144	2X18W TLD	295x31x29x285	10	12,00 \$
313143	1X36W TLD	295x31x29x285	10	12,00 \$
313145	2X36W TLD	295x31x29x285	10	12,00 \$
313158	4X14W T5	332x34x32x322	10	12,00 \$

İgnitör

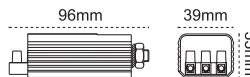

IP 20

Kod No	Özellikler	Koli Adedi	Fiyat
303902	Zaman Ayarlı 50-400W	10	8,00 \$
303884	İgnitör 35-400W	10	6,50 \$
303906	600-1000W (25 m kadar)	10	16,80 \$
303900	İgnitör 600-1000W	10	16,80 \$

Metal Lambalar

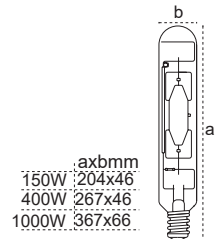

Kod No	Özellikler	Koli Adedi	Fiyat
313523	150W 4200K E40	24	12,00 \$
313514	400W 5500K E40	24	15,00 \$
313512	1000W 5500K E40	20	50,00 \$

Pelsan Balast & Kitler

LED Konvertör Kit (1 Saat)



IP 20 ⊕

Kod No	Özellikler	Koli Adedi	Fiyat
313118	12-110V LED Konvertör Kit (1 Saat)	50	26,00 \$

LED Konvertör Kit (3 Saat)



IP 20 ⊕

Kod No	Özellikler	Koli Adedi	Fiyat
316611	12-110V LED Konvertör Kit (3 Saat)	50	30,30 \$

LED Tube Konvertör Kit



IP 20 ⊕

Kod No	Özellikler	Koli Adedi	Fiyat
313117	9-18W LED Tube Konvertör Kit	25	26,00 \$

IP20 Sabit Akım LED Sürücüler

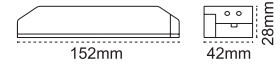

IP 20 ⊕

Kod No	Özellikler	Koli Adedi	Fiyat
316981	36W 700 mA 40-51 V DC Çıkış Gerilimi	200	21,00 \$
316982	36W 800 mA 33-45 V DC Çıkış Gerilimi	200	21,00 \$
316983	36W 900 mA 30-40 V DC Çıkış Gerilimi	200	21,00 \$

Floresan Konvertör Kit (1 Saat)

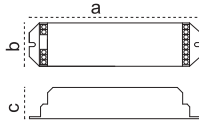

IP 20 ⊕

Kod No	Özellikler	axbxcmm	Koli Adedi	Fiyat
313089	18-36W Mekanik Balast için 1 Saat	170x43x31	10	39,40 \$
313122	18-36W Elektronik Balast için 1 Saat	170x43x31	10	45,00 \$

Floresan Konvertör Kit (3 Saat)

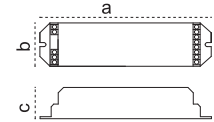

IP 20 ⊕

Kod No	Özellikler	axbxcmm	Koli Adedi	Fiyat
313092	18-36W Mekanik Balast için 3 Saat	170x43x31	10	39,40 \$
313123	18-36W Elektronik Balast için 3 Saat	170x43x31	10	45,00 \$

Tij Takımı



IP 20 ⊕

Kod No	Özellikler	Koli Adedi	Fiyat
304026	Porselen Tij Takımı E27	50	1,50 \$

Starter

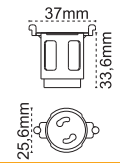

IP 20 ⊕

Kod No	Özellikler	Koli Adedi	Fiyat
303851	Seri 4-22W	25	0,30 \$

Foça

Grup Priz Serisi



Kod No	Cinsi	Koli Ad.	Çeşme Seri
205444	Foça 2'li Klemensli	100	2,50 \$
205441	Foça 2'li 2 mt Kablolu	48	5,50 \$
205442	Foça 2'li 3 mt Kablolu	48	6,60 \$
205443	Foça 2'li 5 mt Kablolu	24	8,75 \$
205448	Foça 3'lü Klemensli	100	3,00 \$
205445	Foça 3'lü 2 mt Kablolu	48	6,00 \$
205446	Foça 3'lü 3 mt Kablolu	48	7,10 \$
205447	Foça 3'lü 5 mt Kablolu	24	9,25 \$
205452	Foça 4'lü Klemensli	100	3,90 \$
205449	Foça 4'lü 2 mt Kablolu	36	6,90 \$
205450	Foça 4'lü 3 mt Kablolu	36	8,00 \$
205451	Foça 4'lü 5 mt Kablolu	24	10,15 \$
205456	Foça 5'li Klemensli	100	4,80 \$
205453	Foça 5'li 2 mt Kablolu	36	7,80 \$
205454	Foça 5'li 3 mt Kablolu	36	8,90 \$
205455	Foça 5'li 5 mt Kablolu	24	11,05 \$
205460	Foça 6'lı Klemensli	100	5,95 \$
205457	Foça 6'lı 2 mt Kablolu	48	8,95 \$
205458	Foça 6'lı 3 mt Kablolu	48	10,05 \$
205459	Foça 6'lı 5 mt Kablolu	24	12,20 \$
UPS Foça			
205461	Ups 5'li 2 mt Kablolu	36	10,80 \$
205462	Ups 5'li 3 mt Kablolu	36	11,90 \$
205463	Ups 5'li 5 mt Kablolu	24	14,05 \$

Foça

Anahtarlı Grup Priz Serisi



Kod No	Cinsi	Koli Ad.	Foça Seri
204353	Anahtarlı 2'li Klemensli	100	4,25 \$
204350	Anahtarlı 2'li 2 mt Kablolu	48	7,35 \$
204351	Anahtarlı 2'li 3 mt Kablolu	48	8,45 \$
204352	Anahtarlı 2'li 5 mt Kablolu	24	10,60 \$
204357	Anahtarlı 3'lü Klemensli	100	4,85 \$
204354	Anahtarlı 3'lü 2 mt Kablolu	48	7,85 \$
204355	Anahtarlı 3'lü 3 mt Kablolu	48	8,95 \$
204356	Anahtarlı 3'lü 5 mt Kablolu	24	11,10 \$
204361	Anahtarlı 4'lü Klemensli	100	5,75 \$
204358	Anahtarlı 4'lü 2 mt Kablolu	36	8,75 \$
204359	Anahtarlı 4'lü 3 mt Kablolu	36	10,75 \$
204360	Anahtarlı 4'lü 5 mt Kablolu	24	12,00 \$
204365	Anahtarlı 5'li Klemensli	100	6,65 \$
204362	Anahtarlı 5'li 2 mt Kablolu	36	9,65 \$
204363	Anahtarlı 5'li 3 mt Kablolu	36	10,75 \$
204364	Anahtarlı 5'li 5 mt Kablolu	24	12,90 \$
204369	Anahtarlı 6'lı Klemensli	100	7,80 \$
204366	Anahtarlı 6'lı 2 mt Kablolu	36	10,80 \$
204367	Anahtarlı 6'lı 3 mt Kablolu	36	11,90 \$
204368	Anahtarlı 6'lı 5 mt Kablolu	24	14,05 \$
UPS Foça Anahtarlı			
204370	5'li 2 mt Kablolu Priz	36	12,65 \$
204371	5'li 3 mt Kablolu Priz	36	13,75 \$
204372	5'li 5 mt Kablolu Priz	24	15,90 \$

Pelsan Grup Prizler

Belek Çocuk Korumalı
Eviniz de Cebiniz de GÜVENDE!

5
YIL
GARANTİ



Çocuk Korumalı



Alev Almaz Gövde
(850°C Isıya Dayanıklı)



Halojen Free Malzeme



Anahtarlı / Anahtarsız
Opsiyonu



Duvara Askı



3'lü Çocuk Korumalı



Kod No	Cinsi	Koli Ad.	Fiyat
204975	3'lü Klemensli (5951 4030)	96	3,40 \$
204922	3'lü 2 mt Kablolu (5951 4032)	48	6,40 \$
204923	3'lü 3 mt Kablolu (5951 4033)	48	7,50 \$
204924	3'lü 5 mt Kablolu (5951 4035)	24	9,65 \$

3'lü Anahtarlı Çocuk Korumalı



Kod No	Cinsi	Koli Ad.	Fiyat
204977	3'lü Klemensli (5951 4130)	96	5,25 \$
204925	3'lü 2 mt Kablolu (5951 4132)	48	7,25 \$
204926	3'lü 3 mt Kablolu (5951 4133)	48	9,35 \$
204927	3'lü 5 mt Kablolu (5951 4135)	24	11,50 \$

4'lü Çocuk Korumalı



Kod No	Cinsi	Koli Ad.	Fiyat
204978	4'lü Klemensli (5951 4040)	72	4,40 \$
204929	4'lü 2 mt Kablolu (5951 4042)	36	7,40 \$
204930	4'lü 3 mt Kablolu (5951 4043)	36	8,50 \$
204931	4'lü 5 mt Kablolu (5951 4045)	24	10,65 \$

4'lü Anahtarlı Çocuk Korumalı



Kod No	Cinsi	Koli Ad.	Fiyat
204979	4'lü Klemensli (5951 4140)	72	6,25 \$
204932	4'lü 2 mt Kablolu (5951 4142)	36	9,25 \$
204933	4'lü 3 mt Kablolu (5951 4143)	36	10,35 \$
204934	4'lü 5 mt Kablolu (5951 4145)	24	12,50 \$

6'lı Çocuk Korumalı



Kod No	Cinsi	Koli Ad.	Fiyat
204980	6'lı Klemensli (5951 4060)	60	6,75 \$
204935	6'lı 2 mt Kablolu (5951 4062)	36	9,75 \$
204936	6'lı 3 mt Kablolu (5951 4063)	36	10,85 \$
204937	6'lı 5 mt Kablolu (5951 4065)	24	13,00 \$

6'lı Anahtarlı Çocuk Korumalı



Kod No	Cinsi	Koli Ad.	Fiyat
204981	6'lı Klemensli (5951 4160)	60	8,60 \$
204938	6'lı 2 mt Kablolu (5951 4162)	36	11,60 \$
204939	6'lı 3 mt Kablolu (5951 4163)	36	12,70 \$
204940	6'lı 5 mt Kablolu (5951 4165)	24	14,85 \$



Belek USB Grup Priz



USB Anahtarlı
Çocuk Korumalı



Kod No	Cinsi	Koli Ad.	Fiyat
204985	Usb 3'lü 2 mt Kablolu (5951 4232)	36	19,10 \$
204986	Usb 3'lü 3 mt Kablolu (5951 4233)	36	20,65 \$
204987	Usb 3'lü 5 mt Kablolu (5951 4235)	24	23,90 \$

Aksesuarlar

Kod No	Cinsi	Koli Ad.	Aksesuar Serisi
204402	Topraksız Erkek Fiş	1000	0,78 \$
204401	Topraklı Erkek Fiş	500	1,10 \$
204400	Topraklı Dişi Fiş	250	1,25 \$
204399	Toprak Erkek L Modeli Fiş	500	1,10 \$



Fişler

Kod No	Cinsi	Koli Ad.	Fiş Prizler Serisi
204395	Fiş Priz 3'lü	100	3,30 \$
204396	Fiş Priz 4'lü	100	4,60 \$
204397	Fiş Priz Trio	100	3,50 \$



Uzatma

Kod No	Cinsi	Koli Ad.	Uzatma Kabloları Serisi
204130	Topraklı Uzatma 3 mt 3x1.0 mm	24	8,90 \$
204131	Topraklı Uzatma 5 mt 3x1.0 mm	50	12,15 \$
204128	Topraklı Uzatma 10 mt 3x1.5 mm	25	29,50 \$

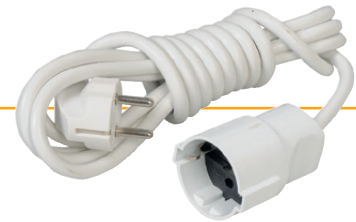

Keira Beyaz Anahtar ve Priz Serisi

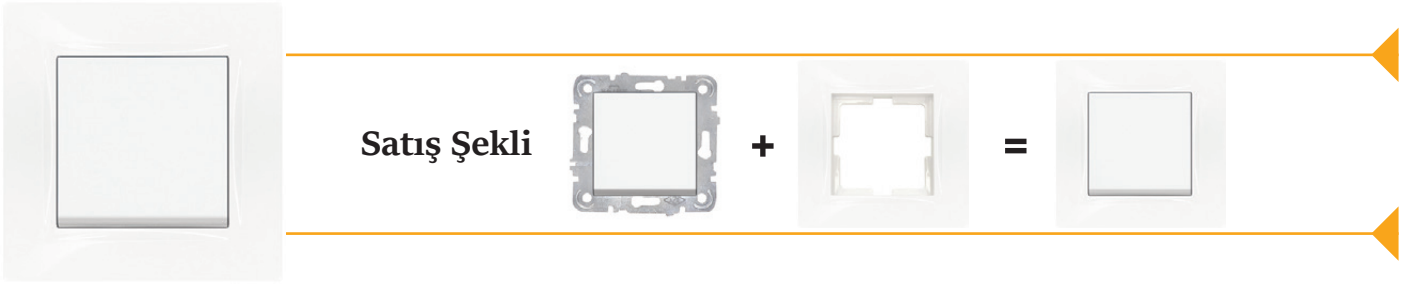
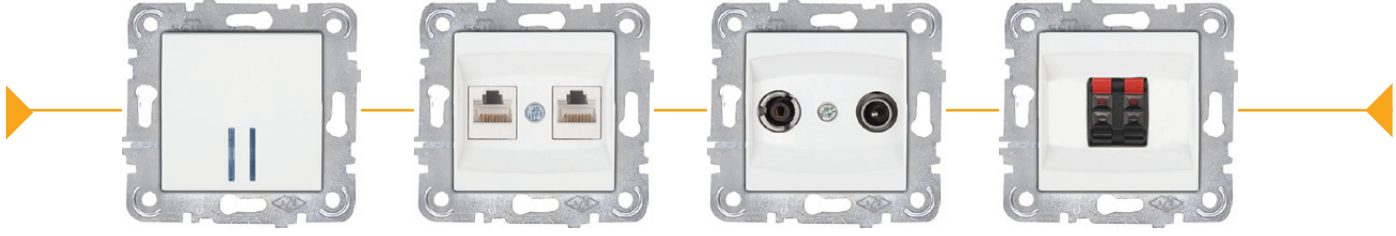

Kod No	Cinsi	Koli Ad.	Keira Beyaz & Krem Seri
Anahtar Grubu			
202558	Anahtar	120	2,20 \$
204991	Light	120	2,27 \$
204992	Kapı otomatığı	120	2,27 \$
204993	Zil anahtar	120	2,27 \$
202561	Komitatör	120	2,67 \$
204994	Vavien	120	2,70 \$
204995	Permitatör	120	3,61 \$
204996	Komitatör vavien	120	3,61 \$
204997	Jaluzi anahtar	120	4,22 \$
204998	Sofben anahtar	120	3,72 \$
204999	3'lü anahtar	120	3,02 \$
Priz Grubu			
205000	Priz	120	2,50 \$
202563	Topraklı priz	120	2,73 \$
205001	Çocuk korumalı topraklı priz	120	3,45 \$
205002	UPS topraklı priz	120	3,20 \$
205153	UPS çocuk korumalı topraklı priz	120	3,61 \$
205004	Kapaklı topraklı priz	120	3,81 \$
205154	Çocuk korumalı kapaklı topraklı priz	120	3,92 \$
205006	UPS kapaklı topraklı priz	120	3,60 \$
TV/Radyo Grubu			
205009	TV priz geçişli	120	3,85 \$
205010	TV priz sonlu	120	3,85 \$
205011	TV priz dirençsiz	120	3,85 \$
205012	Uydu prizi F konnektörlü geçişli	120	4,81 \$
205013	Uydu prizi F konnektörlü sonlu	120	4,91 \$
205014	TV - Radyo priz geçişli	120	14,47 \$
205015	TV - Radyo priz sonlu	120	14,47 \$
205016	TV - Sat priz geçişli	120	14,12 \$
205007	TV - Sat priz sonlu	120	14,12 \$

Kod No	Cinsi	Koli Ad.	Keira Beyaz & Krem Seri
iletışim Grubu			
205008	Numeris telefon prizi (RJ11)	120	2,62 \$
205017	İkili numeris (RJ11)	120	4,11 \$
205018	Data numeris (RJ45CAT5-RJ11)	120	7,44 \$
205022	Data priz (RJ45CAT5)	120	7,44 \$
205020	İkili data priz (RJ45CAT5)	120	12,03 \$
205021	Data jaksız	120	2,62 \$
205022	Data priz (RJ45CAT6)	120	7,44 \$
205023	İkili data priz (RJ45CAT6)	120	12,03 \$
205024	Data - Numeris (RJ45CAT6-RJ11)	120	7,44 \$
205025	Müzik Yayın Prizi	80	5,23 \$
205026	VGA Prizi	80	14,60 \$
205031	Müzik yayın anahtar	80	12,25 \$
Dimmer Grubu			
205027	Dimmer 600W	80	10,70 \$
205028	Dimmer 1000W	80	25,00 \$
205029	Dimmer vavien 600W	80	25,70 \$
205030	Dimmer RC 300W	80	30,00 \$
İşıklı Anahtar Grubu			
205032	İşıklı anahtar	120	3,30 \$
205033	İşıklı light	120	3,30 \$
205034	İşıklı komitatör	120	3,77 \$
205035	İşıklı vavien	120	3,80 \$
205036	İşıklı etiketli zil	120	3,37 \$
205037	İşıklı dimmer 600W	80	11,00 \$
205038	İşıklı dimmer 1000W	80	27,00 \$
205039	İşıklı dimmer vavien 600W	80	27,70 \$
205040	İşıklı dimmer RC 300W	80	32,00 \$
Çerçeveler			
205296	1'li çerçeve	200	0,51 \$
205297	2'li çerçeve yatay-dikey	200	1,46 \$
205298	3'lü çerçeve yatay-dikey	150	1,93 \$
205299	4'lü çerçeve yatay-dikey	50	3,36 \$
205300	5'li çerçeve yatay-dikey	50	3,00 \$
205301	6'li çerçeve yatay-dikey	50	3,50 \$

ATEX Belgeleri

ATEX Belgeli Pelsan Exproof armatürler, tehlikeli gaz ve toz maddelerinin bulunduğu, patlama riski olan ortamlarda güvenle kullanılabilir.

IEP ENERGY PETROLEUM INSTITUTE **IEP ATEX**

(1) **EU- Internal Production Control Certificate**
 (2) **Equipment or Protective Systems Intended for use in Potentially Explosive Atmospheres**
 Directive 2014/34/EU
 (3) EU – Internal Production Control Certificate Number: IEP 16 ATEX 0448
 (4) Product: **Led lighting fixtures, Pelsan xy series**
 (5) Firm Name: **PELSAN AYDINLATMA SANAYİ ve TİCARET A.Ş.**
 (6) Firm Address: **İmes Sanayi Sitesi A Blok 101 Sokak No:38 Dudullu Ümraniye - İSTANBUL, TURKEY**
 (7) This product any of acceptable variation thereto is specified in the schedule to this certificate and the documents therein referred to.
 (8) The IEP Ulaştırılması Enerji Petrol Gözetim, Sertifikasyon ve Teknik Hizmetler Organizasyonu Tic. Ltd. Sti., notified body number 2284 in accordance with Article 17 of the Directive 2014/34/EU of European Parliament and of the Council, dated 26 February 2014, certifies that this product has been found to comply with the Essential Health and Safety Requirements relating to the design and construction of products intended for use in potentially explosive atmospheres, given in Annex II/VIII to the Directive. The examination and test results are recorded in confidential Report Nr: IEP.Kp.Ex.16-1037 date 18.11.2016.
 (9) Compliance with Essential Health and safety requirements has been assured by compliance with:
EN 60079-0 : 2012, EN 60079-15 : 2010, EN 60079-31 : 2009
 (10) If the sign "X" is placed after the certificate number, it indicates that the product is subject to Specified Conditions of Safe Use specified in the schedule to this certificate.
 (11) This EU-Internal Production Control Certificate relates only to the design and construction of the specified product in accordance to the directive 2014/34/EU. Further requirements of the directive apply to the manufacturing process and supply of this product. These are not covered by this certificate. Validity date 10 year. If standard or product change, this certificate is invalid.
 (12) The marking of the equipment or protective system shall include the following:

II 3G Ex nR IIC T5 Gc
II 3D Ex tc IIC (T 95 °C) Dc

Responsible Person :
 Nurettin Terzioğlu
 Head of Certification Body

Date of Issue : 22.11.2016

IEP Ulaştırılması Enerji Petrol Gözetim, Sertifikasyon ve Teknik Hiz. Örg. Tic. Ltd. Sti.
 57461 Sok. No:9 K:2 Beşiktaş - İZMİR / TÜRKİYE
 Tel : +90 232 431 17 45 - 46 Fax : +90 232 431 17 30 E-mail: iep@iep.com.tr Fr: 45
 This certificate is granted subject to the general conditions of the IEP Energy Petroleum Institute. This certificate may only be reproduced in its entirety and without any change, schedule included. You can check accuracy of this document by www.iep.com.tr
 Page 1 / 2

IEP ENERGY PETROLEUM INSTITUTE **IEP ATEX**

(1) **Type Examination Certificate**
 (2) **Equipment or Protective Systems Intended for use in Potentially Explosive Atmospheres**
 Directive 2014/34/EU
 (3) Type Examination Certificate Number: IEP 18 ATEX 0597
 (4) Equipment: **Largo Type , Exproof Luminaires**
 (5) Firm Name: **PELSAN AYDINLATMA SANAYİ ve TİCARET A.Ş.**
 (6) Firm Address: **İmes Sanayi Sitesi A Blok 101 Sok. No:38 V Dudullu - İSTANBUL / TURKEY**
 (7) This equipment or protective system and any of acceptable variation thereto is specified in the schedule to this certificate and the documents therein referred to.
 (8) The IEP Ulaştırılması Enerji Petrol Gözetim, Sertifikasyon ve Teknik Hizmetler Organizasyonu Tic. Ltd. Sti., certifies that this equipment or protective system has been found to comply with the Essential Health and Safety Requirements relating to the design and construction of category 3 equipment, which is intended for use in potentially explosive atmospheres, given in Annex II to the Council Directive 2014/34/EU. The examination and test results are recorded in confidential Report Nr: IEP.Kp.Ex.18-1281 date 28.05.2018.
 (9) Compliance with Essential Health and safety requirements has been assured by compliance with:
EN 60079-0:2013, EN 60079-15:2010, EN 60079-31:2014
 (10) If the sign "X" is placed after the certificate number, it indicates that the product is subject to Specified Conditions of Safe Use specified in the schedule to this certificate.
 (11) This Type Examination Certificate relates only to the design and specification for construction of the equipment or protective system. It does not cover process for actual manufacture or supply of the equipment or protective system, for which further requirements of the directive are applicable.
 (12) The marking of the equipment or protective system shall include the following:

II 3G Ex nR IIC T5 Gc
II 3D Ex tc IIC T 80° C Dc

Responsible Person:
 Nurettin Terzioğlu
 Head of Certification Body

Date of Issue: 31.05.2018

IEP Ulaştırılması Enerji Petrol Gözetim, Sertifikasyon ve Teknik Hiz. Örg. Tic. Ltd. Sti.
 57461 Sok. No:9 K:2 Beşiktaş - İZMİR / TÜRKİYE
 Tel : +90 232 431 17 45 - 46 Fax : +90 232 431 17 30 E-mail: iep@iep.com.tr Fr: 45
 This certificate is granted subject to the general conditions of the IEP Energy Petroleum Institute. This certificate may only be reproduced in its entirety and without any change, schedule included. You can check accuracy of this document by www.iep.com.tr
 Page 1 / 2

Türk Akreditasyon Sertifikası

Türk Akreditasyon Kurumu tarafından akredite olan laboratuvarımız ile tüm aydınlatma armatürlerini standartlara uygun olarak test ediyoruz.

TÜRKAK TÜRK AKREDİTASYON KURUMU

AKREDİTASYON SERTİFİKASI

Deney Laboratuvarı olarak faaliyet gösteren,

PELSAN AYDINLATMA SANAYİ VE TİCARET A.Ş. Pelsan Aydınlatma Laboratuvarı

Çerkeçli OSB İmes 5.Cadde 400 Ada 6 Parsel Dış Kapı No:12 Döğüsü KOCAELİ / TÜRKİYE

TÜRKAK tarafından yapılan denetim sonucunda TS EN ISO/IEC 17025:2017 Standardına göre Ek'te yer alan kapsamlarda akredite edilmiştir.

Akreditasyon No : AB-0795-T
 Akreditasyon Tarihi : 28 Nisan 2015
 Revizyon Tarihi / No : 27 Ağustos 2019 / 04

Bu Sertifika, yukarıda açık adı ve adresi yazılı Kuruluşun TS EN ISO/IEC 17025:2017 Standardına, ilgili Yönetmelik ve Tebliğlere uygunluğunu sürdürmesi halinde, 28 Ağustos 2023 tarihine kadar geçerlidir.

Orbay EVRENSEVDİ
 Genel Sekreter V.

Türk Akreditasyon Kurumu (TÜRKAK) ISO/IEC 17025 alanında Avrupa Akreditasyon Birliği (EA) ve Uluslararası Laboratuvar Akreditasyon Birliği (ILAC) ile çok taraflı anlaşma (MLAMRA) imzalamıştır.

F701-040 -990 312 410 82 00 - www.turkak.org.tr

TSE Belgeleri

TÜRK STANDARLARI ENSTİTÜSÜ
TÜRK STANDARLARINA UYGUNLUK BELGESİ
TURKISH STANDARDS INSTITUTION
CERTIFICATE OF CONFORMITY TO TURKISH STANDARDS

BELEGE NUMARASI 00389-TSE-0163
BELEGENİN İL VE YERİNE TABİTİ 22.12.2025
BELEGENİN SON GEÇERLİLİK TARİHİ 12.12.2027

BELEGE SAHİBİ KURULUŞUN ADI FELSAN AYDINLATMA SANAYİ VE TİCARET ANONİM ŞİRKETİ
BELEGE SAHİBİ KURULUŞUN ADRESİ İSTANBUL BEYOĞLU ENYENYEZ MAHAL YANIKKARI FORKLUK SOK. NO:11 İSTANBUL/TÜRKİYE
ÜRETİM YERİ ADI FELSAN AYDINLATMA SANAYİ VE TİCARET ANONİM ŞİRKETİ
ÜRETİM YERİ ADRESİ ÇEKİRCİ OSM İBRAHİM CADDESİ NO:10 DİĞİNE KOCALIKI TÜRKİYE
İPTAL EDİLEN BELEGE NUMARASI (Yenisi) 00389-TSE-0162
TEKİLLİK TARİHİ FELSAN
İÇİŞİLERİ BAKANLIĞI TS EN 60598-2-1:2014-2015 - TS EN 60598-1:2014-2015
BELEGE KAPSAMI SCOPES OF CERTIFICATE

İzmir, Egeygen Sanayi (Ege Sanayi) Mahallesi, 2201 V. 12. Blok, 12. Kat, No: 12, 35010 Çeşme/İzmir
İzmir, Egeygen Sanayi (Ege Sanayi) Mahallesi, 2201 V. 12. Blok, 12. Kat, No: 12, 35010 Çeşme/İzmir
İzmir, Egeygen Sanayi (Ege Sanayi) Mahallesi, 2201 V. 12. Blok, 12. Kat, No: 12, 35010 Çeşme/İzmir

13.07.2027
Belgeyi Onaylayan Müdür: **Alihan İNCE**
TSE İSTANBUL BELGELENDİRME MÜDÜRLÜĞÜ

TÜRK STANDARLARI ENSTİTÜSÜ
TÜRK STANDARLARINA UYGUNLUK BELGESİ
TURKISH STANDARDS INSTITUTION
CERTIFICATE OF CONFORMITY TO TURKISH STANDARDS

BELEGE NUMARASI 00389-TSE-0094
BELEGENİN İL VE YERİNE TABİTİ 21.04.2020
BELEGENİN SON GEÇERLİLİK TARİHİ 12.12.2027

BELEGE SAHİBİ KURULUŞUN ADI FELSAN AYDINLATMA SANAYİ VE TİCARET ANONİM ŞİRKETİ
BELEGE SAHİBİ KURULUŞUN ADRESİ İSTANBUL BEYOĞLU ENYENYEZ MAHAL YANIKKARI FORKLUK SOK. NO:11 İSTANBUL/TÜRKİYE
ÜRETİM YERİ ADI FELSAN AYDINLATMA SANAYİ VE TİCARET ANONİM ŞİRKETİ
ÜRETİM YERİ ADRESİ ÇEKİRCİ OSM İBRAHİM CADDESİ NO:10 DİĞİNE KOCALIKI TÜRKİYE
İPTAL EDİLEN BELEGE NUMARASI (Yenisi) 00389-TSE-0093
TEKİLLİK TARİHİ FELSAN
İÇİŞİLERİ BAKANLIĞI TS EN 60598-2-1:2014-2015 - TS EN 60598-1:2014-2015
BELEGE KAPSAMI SCOPES OF CERTIFICATE

İzmir, Egeygen Sanayi (Ege Sanayi) Mahallesi, 2201 V. 12. Blok, 12. Kat, No: 12, 35010 Çeşme/İzmir
İzmir, Egeygen Sanayi (Ege Sanayi) Mahallesi, 2201 V. 12. Blok, 12. Kat, No: 12, 35010 Çeşme/İzmir
İzmir, Egeygen Sanayi (Ege Sanayi) Mahallesi, 2201 V. 12. Blok, 12. Kat, No: 12, 35010 Çeşme/İzmir

13.07.2027
Belgeyi Onaylayan Müdür: **Alihan İNCE**
TSE İSTANBUL BELGELENDİRME MÜDÜRLÜĞÜ

TÜRK STANDARLARI ENSTİTÜSÜ
TÜRK STANDARLARINA UYGUNLUK BELGESİ
TURKISH STANDARDS INSTITUTION
CERTIFICATE OF CONFORMITY TO TURKISH STANDARDS

BELEGE NUMARASI 00389-TSE-0199
BELEGENİN İL VE YERİNE TABİTİ 19.02.2020
BELEGENİN SON GEÇERLİLİK TARİHİ 12.12.2027

BELEGE SAHİBİ KURULUŞUN ADI FELSAN AYDINLATMA SANAYİ VE TİCARET ANONİM ŞİRKETİ
BELEGE SAHİBİ KURULUŞUN ADRESİ İSTANBUL BEYOĞLU ENYENYEZ MAHAL YANIKKARI FORKLUK SOK. NO:11 İSTANBUL/TÜRKİYE
ÜRETİM YERİ ADI FELSAN AYDINLATMA SANAYİ VE TİCARET ANONİM ŞİRKETİ
ÜRETİM YERİ ADRESİ ÇEKİRCİ OSM İBRAHİM CADDESİ NO:10 DİĞİNE KOCALIKI TÜRKİYE
İPTAL EDİLEN BELEGE NUMARASI (Yenisi) 00389-TSE-0198
TEKİLLİK TARİHİ FELSAN
İÇİŞİLERİ BAKANLIĞI TS EN 60598-2-1:2014-2015 - TS EN 60598-1:2014-2015
BELEGE KAPSAMI SCOPES OF CERTIFICATE

İzmir, Egeygen Sanayi (Ege Sanayi) Mahallesi, 2201 V. 12. Blok, 12. Kat, No: 12, 35010 Çeşme/İzmir
İzmir, Egeygen Sanayi (Ege Sanayi) Mahallesi, 2201 V. 12. Blok, 12. Kat, No: 12, 35010 Çeşme/İzmir
İzmir, Egeygen Sanayi (Ege Sanayi) Mahallesi, 2201 V. 12. Blok, 12. Kat, No: 12, 35010 Çeşme/İzmir

21.10.2025
Belgeyi Onaylayan Müdür: **Alihan İNCE**
TSE İSTANBUL BELGELENDİRME MÜDÜRLÜĞÜ

TÜRK STANDARLARI ENSTİTÜSÜ
TÜRK STANDARLARINA UYGUNLUK BELGESİ
TURKISH STANDARDS INSTITUTION
CERTIFICATE OF CONFORMITY TO TURKISH STANDARDS

BELEGE NUMARASI 00389-TSE-0096
BELEGENİN İL VE YERİNE TABİTİ 20.04.2020
BELEGENİN SON GEÇERLİLİK TARİHİ 14.03.2027

BELEGE SAHİBİ KURULUŞUN ADI FELSAN AYDINLATMA SANAYİ VE TİCARET ANONİM ŞİRKETİ
BELEGE SAHİBİ KURULUŞUN ADRESİ İSTANBUL BEYOĞLU ENYENYEZ MAHAL YANIKKARI FORKLUK SOK. NO:11 İSTANBUL/TÜRKİYE
ÜRETİM YERİ ADI FELSAN AYDINLATMA SANAYİ VE TİCARET ANONİM ŞİRKETİ
ÜRETİM YERİ ADRESİ ÇEKİRCİ OSM İBRAHİM CADDESİ NO:10 DİĞİNE KOCALIKI TÜRKİYE
İPTAL EDİLEN BELEGE NUMARASI (Yenisi) 00389-TSE-0095
TEKİLLİK TARİHİ FELSAN
İÇİŞİLERİ BAKANLIĞI TS EN 60598-2-1:2014-2015 - TS EN 60598-1:2014-2015
BELEGE KAPSAMI SCOPES OF CERTIFICATE

İzmir, Egeygen Sanayi (Ege Sanayi) Mahallesi, 2201 V. 12. Blok, 12. Kat, No: 12, 35010 Çeşme/İzmir
İzmir, Egeygen Sanayi (Ege Sanayi) Mahallesi, 2201 V. 12. Blok, 12. Kat, No: 12, 35010 Çeşme/İzmir
İzmir, Egeygen Sanayi (Ege Sanayi) Mahallesi, 2201 V. 12. Blok, 12. Kat, No: 12, 35010 Çeşme/İzmir

17.05.2027
Belgeyi Onaylayan Müdür: **Alihan İNCE**
TSE İSTANBUL BELGELENDİRME MÜDÜRLÜĞÜ

Yol ve Caddede Armatürleri

Projektörler

Genel Amaçlı Sabit Armatürler

Sıva Altı Armatürler

TÜRK STANDARLARI ENSTİTÜSÜ
TÜRK STANDARLARINA UYGUNLUK BELGESİ
TURKISH STANDARDS INSTITUTION
CERTIFICATE OF CONFORMITY TO TURKISH STANDARDS

BELEGE NUMARASI 00389-TSE-0162
BELEGENİN İL VE YERİNE TABİTİ 18.10.2025
BELEGENİN SON GEÇERLİLİK TARİHİ 18.10.2027

BELEGE SAHİBİ KURULUŞUN ADI FELSAN AYDINLATMA SANAYİ VE TİCARET ANONİM ŞİRKETİ
BELEGE SAHİBİ KURULUŞUN ADRESİ İSTANBUL BEYOĞLU ENYENYEZ MAHAL YANIKKARI FORKLUK SOK. NO:11 İSTANBUL/TÜRKİYE
ÜRETİM YERİ ADI FELSAN AYDINLATMA SANAYİ VE TİCARET ANONİM ŞİRKETİ
ÜRETİM YERİ ADRESİ ÇEKİRCİ OSM İBRAHİM CADDESİ NO:10 DİĞİNE KOCALIKI TÜRKİYE
İPTAL EDİLEN BELEGE NUMARASI (Yenisi) 00389-TSE-0161
TEKİLLİK TARİHİ FELSAN
İÇİŞİLERİ BAKANLIĞI TS EN 60598-2-1:2014-2015 - TS EN 60598-1:2014-2015
BELEGE KAPSAMI SCOPES OF CERTIFICATE

İzmir, Egeygen Sanayi (Ege Sanayi) Mahallesi, 2201 V. 12. Blok, 12. Kat, No: 12, 35010 Çeşme/İzmir
İzmir, Egeygen Sanayi (Ege Sanayi) Mahallesi, 2201 V. 12. Blok, 12. Kat, No: 12, 35010 Çeşme/İzmir
İzmir, Egeygen Sanayi (Ege Sanayi) Mahallesi, 2201 V. 12. Blok, 12. Kat, No: 12, 35010 Çeşme/İzmir

13.03.2027
Belgeyi Onaylayan Müdür: **Alihan İNCE**
TSE İSTANBUL BELGELENDİRME MÜDÜRLÜĞÜ

Acil Aydınlatma Armatürleri

TÜRK STANDARLARI ENSTİTÜSÜ
TÜRK STANDARLARINA UYGUNLUK BELGESİ
TURKISH STANDARDS INSTITUTION
CERTIFICATE OF CONFORMITY TO TURKISH STANDARDS

BELEGE NUMARASI 00389-TSE-0095
BELEGENİN İL VE YERİNE TABİTİ 22.03.2027
BELEGENİN SON GEÇERLİLİK TARİHİ 12.12.2027

BELEGE SAHİBİ KURULUŞUN ADI FELSAN AYDINLATMA SANAYİ VE TİCARET ANONİM ŞİRKETİ
BELEGE SAHİBİ KURULUŞUN ADRESİ İSTANBUL BEYOĞLU ENYENYEZ MAHAL YANIKKARI FORKLUK SOK. NO:11 İSTANBUL/TÜRKİYE
ÜRETİM YERİ ADI FELSAN AYDINLATMA SANAYİ VE TİCARET ANONİM ŞİRKETİ
ÜRETİM YERİ ADRESİ ÇEKİRCİ OSM İBRAHİM CADDESİ NO:10 DİĞİNE KOCALIKI TÜRKİYE
İPTAL EDİLEN BELEGE NUMARASI (Yenisi) 00389-TSE-0094
TEKİLLİK TARİHİ FELSAN
İÇİŞİLERİ BAKANLIĞI TS EN 60598-2-1:2014-2015 - TS EN 60598-1:2014-2015
BELEGE KAPSAMI SCOPES OF CERTIFICATE

İzmir, Egeygen Sanayi (Ege Sanayi) Mahallesi, 2201 V. 12. Blok, 12. Kat, No: 12, 35010 Çeşme/İzmir
İzmir, Egeygen Sanayi (Ege Sanayi) Mahallesi, 2201 V. 12. Blok, 12. Kat, No: 12, 35010 Çeşme/İzmir
İzmir, Egeygen Sanayi (Ege Sanayi) Mahallesi, 2201 V. 12. Blok, 12. Kat, No: 12, 35010 Çeşme/İzmir

13.03.2027
Belgeyi Onaylayan Müdür: **Alihan İNCE**
TSE İSTANBUL BELGELENDİRME MÜDÜRLÜĞÜ

Fiş ve Prizler

TÜRK STANDARLARI ENSTİTÜSÜ
TÜRK STANDARLARINA UYGUNLUK BELGESİ
TURKISH STANDARDS INSTITUTION
CERTIFICATE OF CONFORMITY TO TURKISH STANDARDS

BELEGE NUMARASI 00389-TSE-0093
BELEGENİN İL VE YERİNE TABİTİ 07.06.2023
BELEGENİN SON GEÇERLİLİK TARİHİ 18.12.2027

BELEGE SAHİBİ KURULUŞUN ADI FELSAN AYDINLATMA SANAYİ VE TİCARET ANONİM ŞİRKETİ
BELEGE SAHİBİ KURULUŞUN ADRESİ İSTANBUL BEYOĞLU ENYENYEZ MAHAL YANIKKARI FORKLUK SOK. NO:11 İSTANBUL/TÜRKİYE
ÜRETİM YERİ ADI FELSAN AYDINLATMA SANAYİ VE TİCARET ANONİM ŞİRKETİ
ÜRETİM YERİ ADRESİ ÇEKİRCİ OSM İBRAHİM CADDESİ NO:10 DİĞİNE KOCALIKI TÜRKİYE
İPTAL EDİLEN BELEGE NUMARASI (Yenisi) 00389-TSE-0092
TEKİLLİK TARİHİ FELSAN
İÇİŞİLERİ BAKANLIĞI TS EN 60598-2-1:2014-2015 - TS EN 60598-1:2014-2015
BELEGE KAPSAMI SCOPES OF CERTIFICATE

İzmir, Egeygen Sanayi (Ege Sanayi) Mahallesi, 2201 V. 12. Blok, 12. Kat, No: 12, 35010 Çeşme/İzmir
İzmir, Egeygen Sanayi (Ege Sanayi) Mahallesi, 2201 V. 12. Blok, 12. Kat, No: 12, 35010 Çeşme/İzmir
İzmir, Egeygen Sanayi (Ege Sanayi) Mahallesi, 2201 V. 12. Blok, 12. Kat, No: 12, 35010 Çeşme/İzmir

13.03.2027
Belgeyi Onaylayan Müdür: **Alihan İNCE**
TSE İSTANBUL BELGELENDİRME MÜDÜRLÜĞÜ

Anahtarlar

ENEC Belgeleri

bsi.
ENEC Certificate

Product Name: Projeksiyonlu Acil Aydınlatma Armatürü
Model: CSD-300
Country: Turkey

ENEC Certificate Number: ENEC 813233

ENEC Standard: EN 60598-2-6 Floodlight

Manufacturer: Felsan, Çekirge Sanayi ve Ticaret A.Ş.

Page 1 of 4

bsi.
ENEC Certificate

Product Name: Projeksiyonlu Acil Aydınlatma Armatürü
Model: CSD-300
Country: Turkey

ENEC Certificate Number: ENEC 611005

ENEC Standard: EN 60598-2-6 Floodlight

Manufacturer: Felsan, Çekirge Sanayi ve Ticaret A.Ş.

Page 1 of 4

Yol ve Caddede Armatürleri

Projektörler

EAC Belgeleri

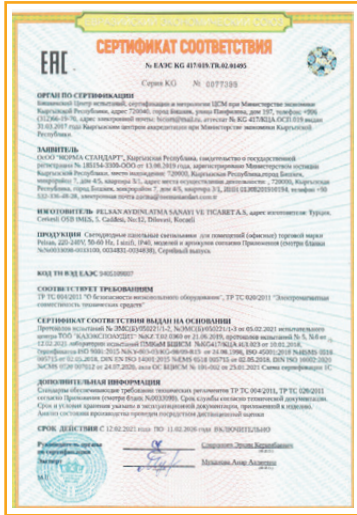

Ofis Armatürler

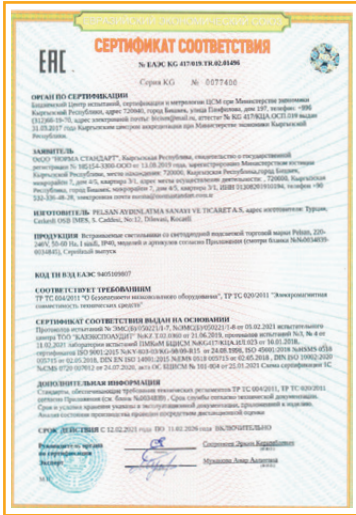

Downlight

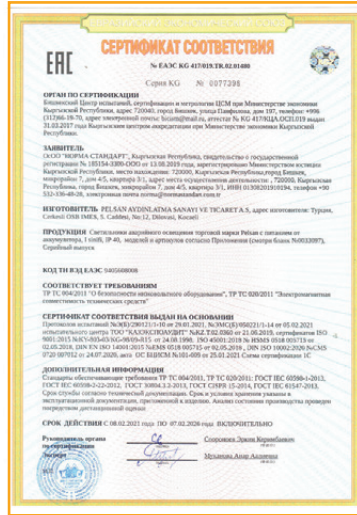

Acil Aydınlatma Armatürleri

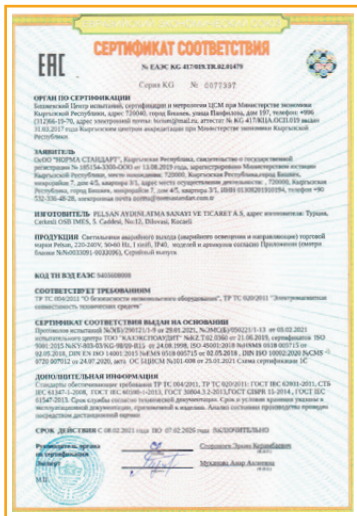

Acil Aydınlatma ve Yönlendirme Armatürleri

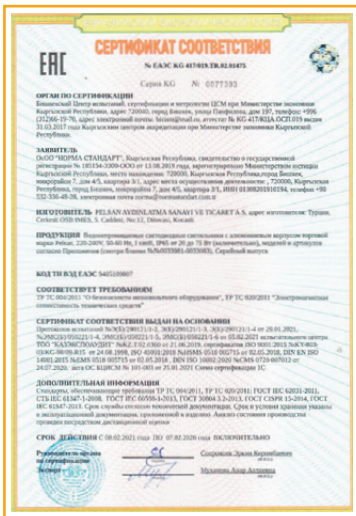

Etanj Armatürler

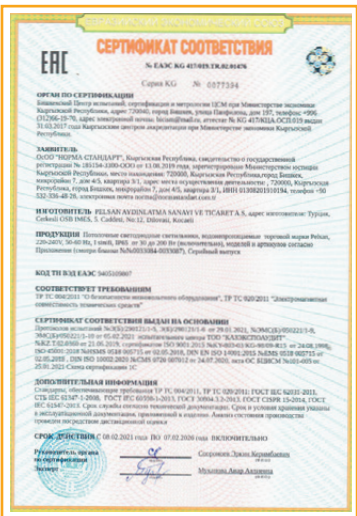

Yüksek Tavan Armatürleri

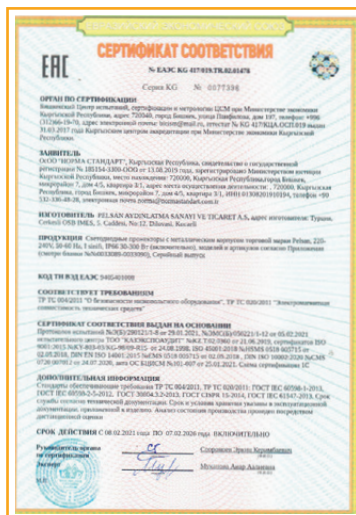

Projektörler

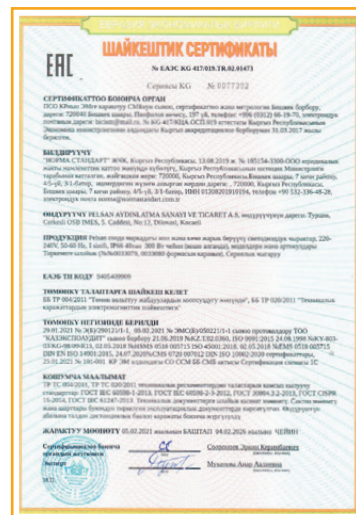

Yol ve Cadde Armatürleri

Yerli Malı Belgeleri



Genel Amaçlı Sabit Armatürler



LED'li Genel Amaçlı Armatürler



Sıva Altı Armatürler



Etanj Armatürler



Yol ve Cadde Armatürleri



Projektörler



Yeni Ürün
60-150W

5
YIL
GARANTİ



W 60-150W

7560lm - 17700lm

100.000h Driver Ömrü

10kV Dahili Parafudr

IP66, Toz ve Su Almaz!

Gerilim Dalgalanmalarından Etkilenmez 100-305VAC @48h

Lens Opsiyonları

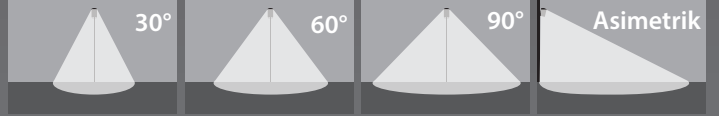

Güncel ürün bilgisi ve belgeleri için www.pelsan.com.tr' yi ziyaret ediniz.

www.pelsan.com.tr
info@pelsan.com.tr | export@pelsan.com.tr

Pelsan TÜM AYDINLATMA İHTİYAÇLARINIZ İÇİN TEK ADRES

GENEL MERKEZ
İmes Sanayi Sitesi
A Blok 101 Sk. No:38
Y.Dudullu / İstanbul
T: (0850) 460 75 76
F: (0212) 364 60 15

FABRİKA
Çerkeşli O.S.B. İmes
5.Cadde No:12
Dilovası / Kocaeli
T: (0850) 460 75 76
F: (0212) 364 60 15

KARAKÖY MERKEZ
Emekyemez Mah.
Yanıkkapı Porsuk Sk.
No:11 Karaköy / İstanbul
T: (0850) 460 75 76
F: (0212) 364 60 15

PERPA BÖLGE OFİSİ
Perpa Ticaret Merkezi
A Blok Kat:9 No:1178
Okmeydanı / İstanbul
T: (0850) 460 75 76
F: (0212) 364 60 15

Fiyatlara K.D.V. dahil değildir. Pelsan Aydınlatma gerekli koşullarda fiyat ve ürün değiştirme hakkını saklı tutar.

